

ERNEST ELECTRO PUMPS

Supplied by:

e **rnest**
lectro
ngineering (Pty) Ltd.
ARMATURE & MOTOR REWINDING

370 Kruger Road, Strijdom Park, Randburg, South Africa
Tel: (011) 792 9550 / 1 / 2 Fax: (011) 792 9553
E-mail: eeeaman@mweb.co.za Website: ernestee.co.za

PM18

4" SUBMERSIBLE PUMPS

ERNEST ELECTRO PUMPS

50 Hz - n = 2900 rpm

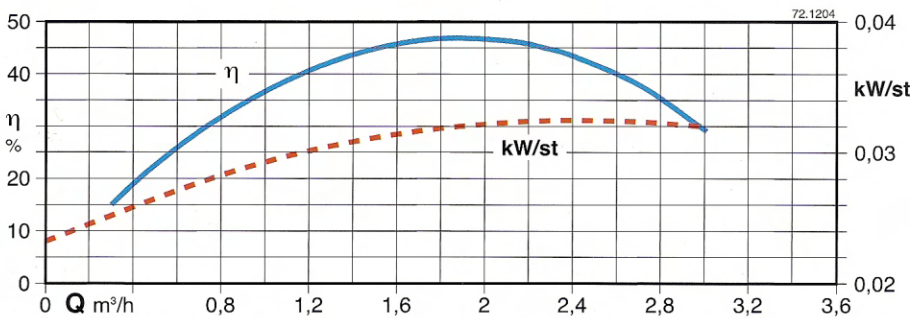
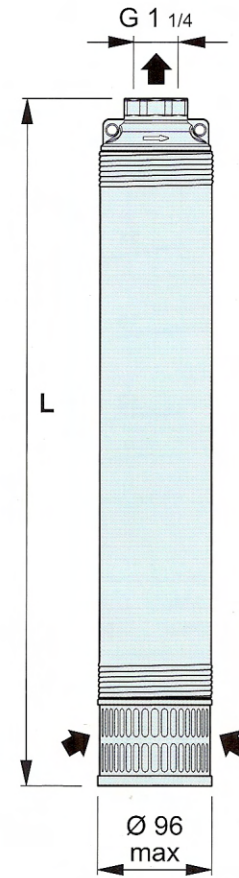
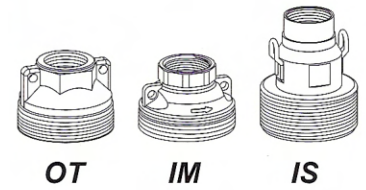
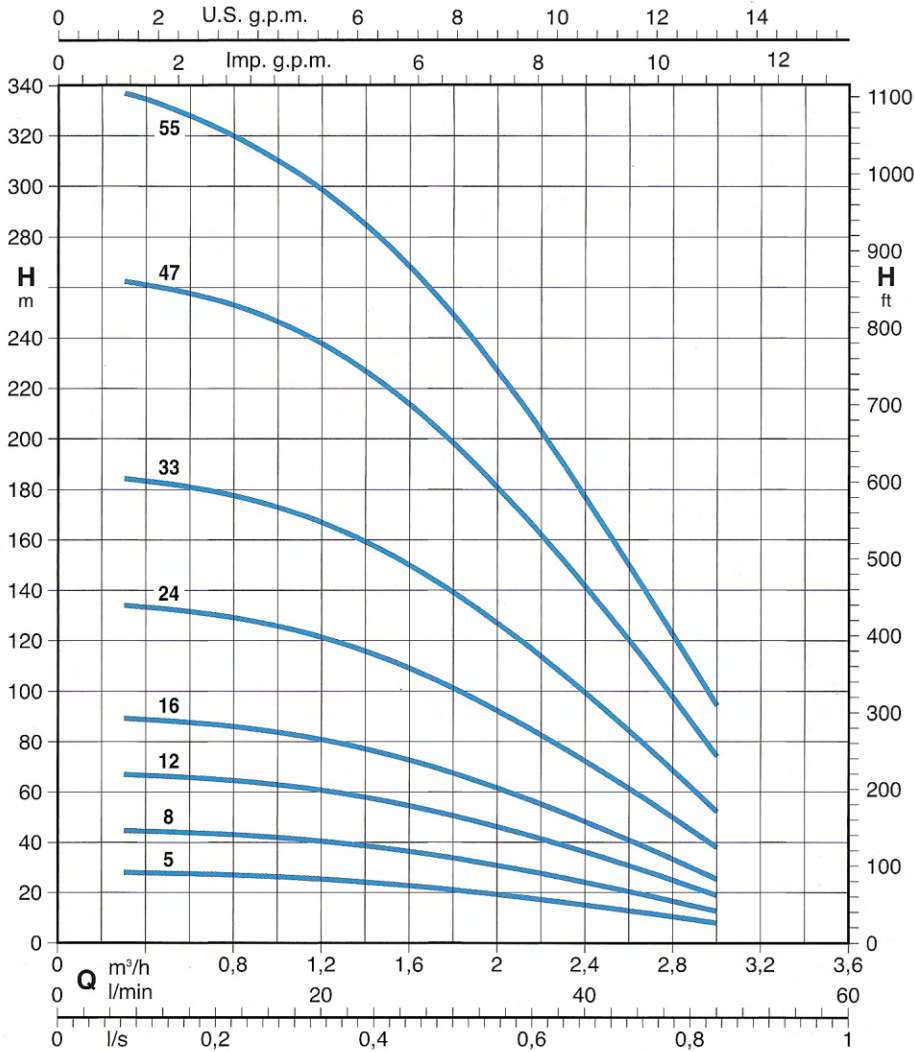

Supplied by:

Ernest Electro Engineering (Pty) Ltd.
ARMATURE & MOTOR REWINDING

370 Kruger Road, Strijdom Park, Randburg, South Africa
 Tel: (011) 792 9550 / 1 / 2 Fax: (011) 792 9553
 E-mail: eeaman@mweb.co.za Website: ernestee.co.za

TYPE	P ₂		Q	n ≈ 2900 1/min											
				m³/h											
	kW	HP		0	0,3	0,6	0,9	1,2	1,5	1,8	2,1	2,25	2,4	2,7	3
PM 18-5	0,25	0,33	H m	28,3	27,9	27,4	26,6	25,3	23,4	21,1	18,2	16,7	15	11,6	7,9
PM 18-8	0,37	0,5		45,3	44,6	43,8	42,5	40,4	37,5	33,7	29,2	26,7	24,1	18,5	12,6
PM 18-12	0,55	0,75		67,9	67	65,8	63,8	60,7	56,3	50,6	43,7	40	36,1	27,8	18,9
PM 18-16	0,75	1		90,5	89,3	87,7	85	80,9	75	67,4	58,3	53,3	48,1	37,1	25,2
PM 18-24	1,1	1,5		136	134	132	128	121	113	101	87,5	80	72,2	55,6	37,8
PM 18-33	1,5	2		187	184	181	175	167	155	139	120	110	99,2	76,5	52
PM 18-47	2,2	3		266	263	258	250	238	220	198	171	157	141	109	74,1
PM 18-55	3	4		339	337	328	315	298	277	249	215	196	177	136	94,2

OT - IM		IS	
L		L	
mm	kg	mm	kg
295	3,1	330	2,3
365	3,6	395	2,8
455	4,2	485	3,4
545	4,9	575	4,1
725	6,2	755	5,4
930	7,6	960	6,8
1290	10,4	1325	9,6
1480	11,9	1510	11,1

PM28

4" SUBMERSIBLE PUMPS

ERNEST ELECTRO PUMPS

50 Hz - n = 2900 rpm

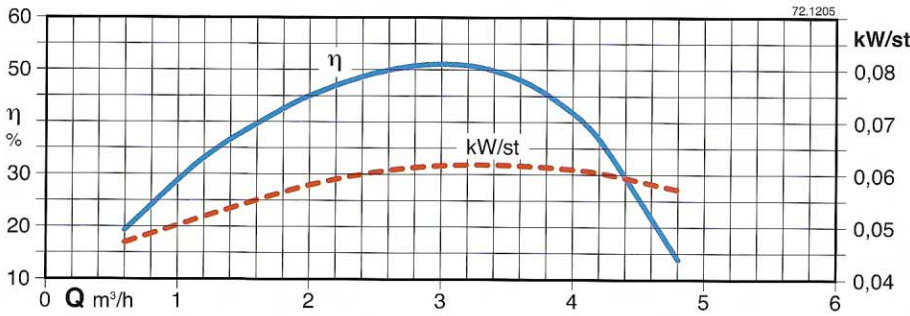
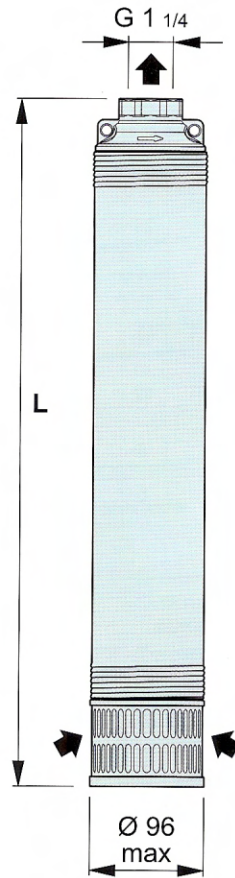
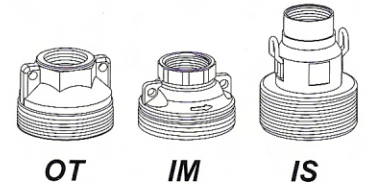
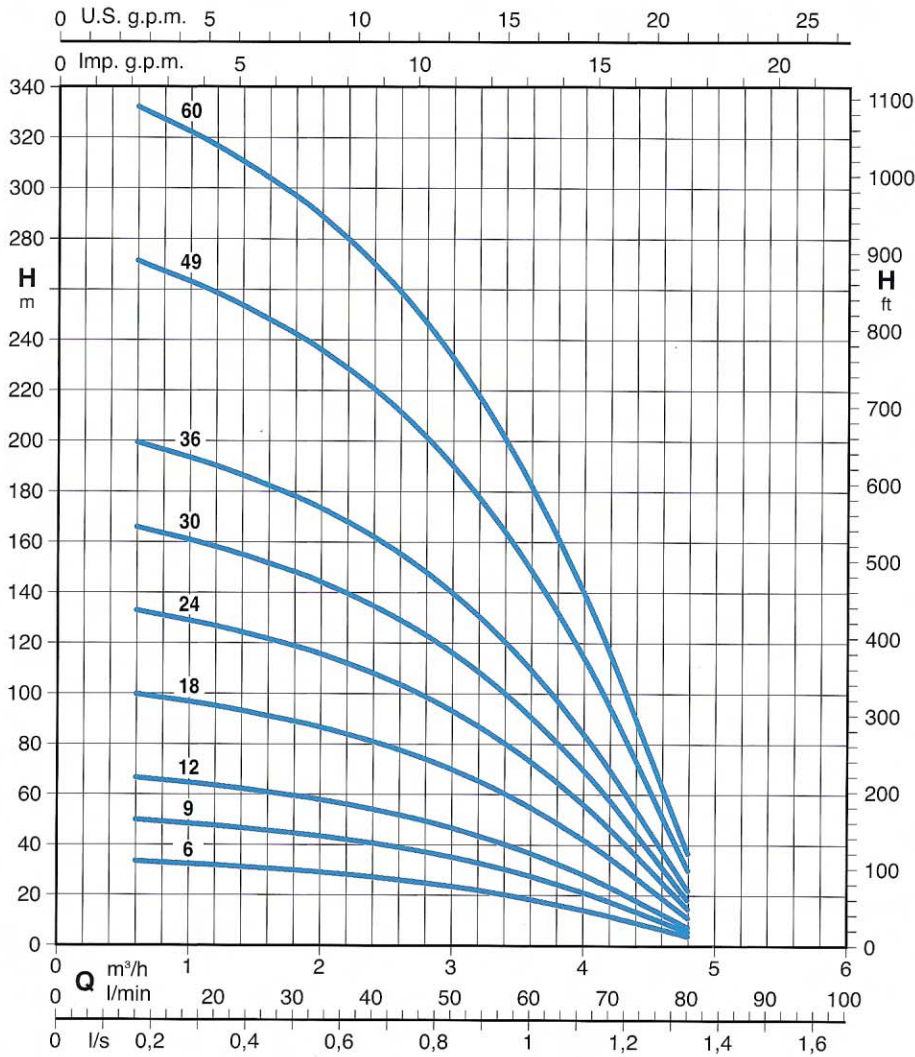

Supplied by:

Ernest Electro Engineering (Pty) Ltd.
ARMATURE & MOTOR REWINDING

370 Kruger Road, Strijdom Park, Randburg, South Africa
 Tel: (011) 792 9550 / 1 / 2 Fax: (011) 792 9553
 E-mail: eeeaman@mweb.co.za Website: ernestee.co.za

TYPE	P ₂		Q	n ≈ 2900 1/min											
				kW		HP		H _m							
	0	0,6		1,2	1,8	2,1	2,4	2,7	3	3,3	3,6	4,2	4,8		
PM 28-6	0,37	0,5	34,5	33,1	31,6	29,6	28,4	26,9	25,2	23,2	20,9	18,2	11,6	3,6	
PM 28-9	0,55	0,75	51,7	49,7	47,4	44,4	42,6	40,4	37,8	34,8	31,3	27,3	17,4	5,4	
PM 28-12	0,75	1	69	66,3	63,2	59,2	56,7	53,9	50,5	46,5	41,8	36,4	23,2	7,3	
PM 28-18	1,1	1,5	104	99,4	94,7	88,8	85,1	80,8	75,7	69,7	62,7	54,5	34,8	10,9	
PM 28-24	1,5	2	138	133	126	118	113	108	101	92,9	83,6	72,7	46,4	14,5	
PM 28-30	2,2	3	173	166	158	148	142	135	126	116	104	90,9	58	18,2	
PM 28-36	2,2	3	207	199	189	178	170	162	151	139	125	109	69,5	21,8	
PM 28-49	3	4	282	271	258	242	232	220	206	190	171	148	94,6	29,6	
PM 28-60	4	5,5	345	331	316	296	284	269	252	232	209	182	116	36,3	

OT - IM		IS	
L		L	
mm	kg	mm	kg
345	3,4	375	2,4
425	4,0	455	3,0
505	4,6	535	3,6
660	5,7	690	4,8
820	6,8	850	6,0
980	8,0	1010	7,2
1145	9,3	1175	8,3
1535	12,0	1565	11,1
1835	14,2	1865	13,3

PM45

4" SUBMERSIBLE PUMPS

ERNEST ELECTRO PUMPS

50 Hz - n = 2900 rpm

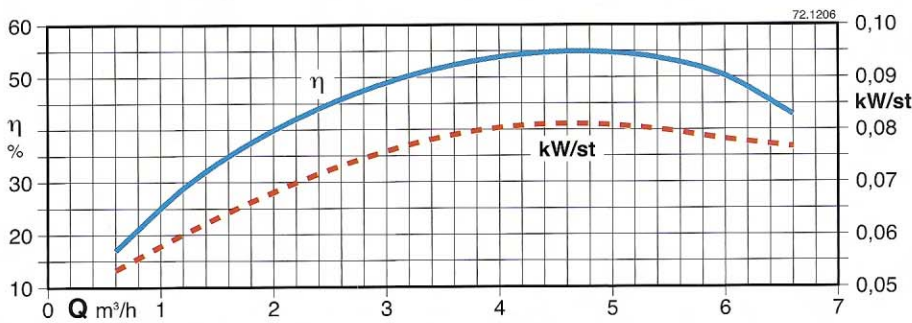
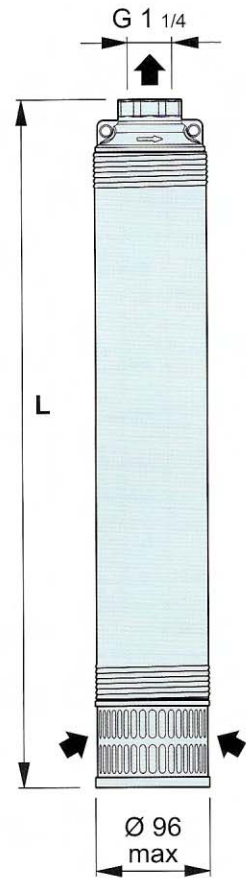
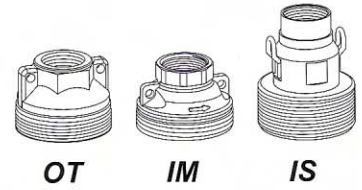
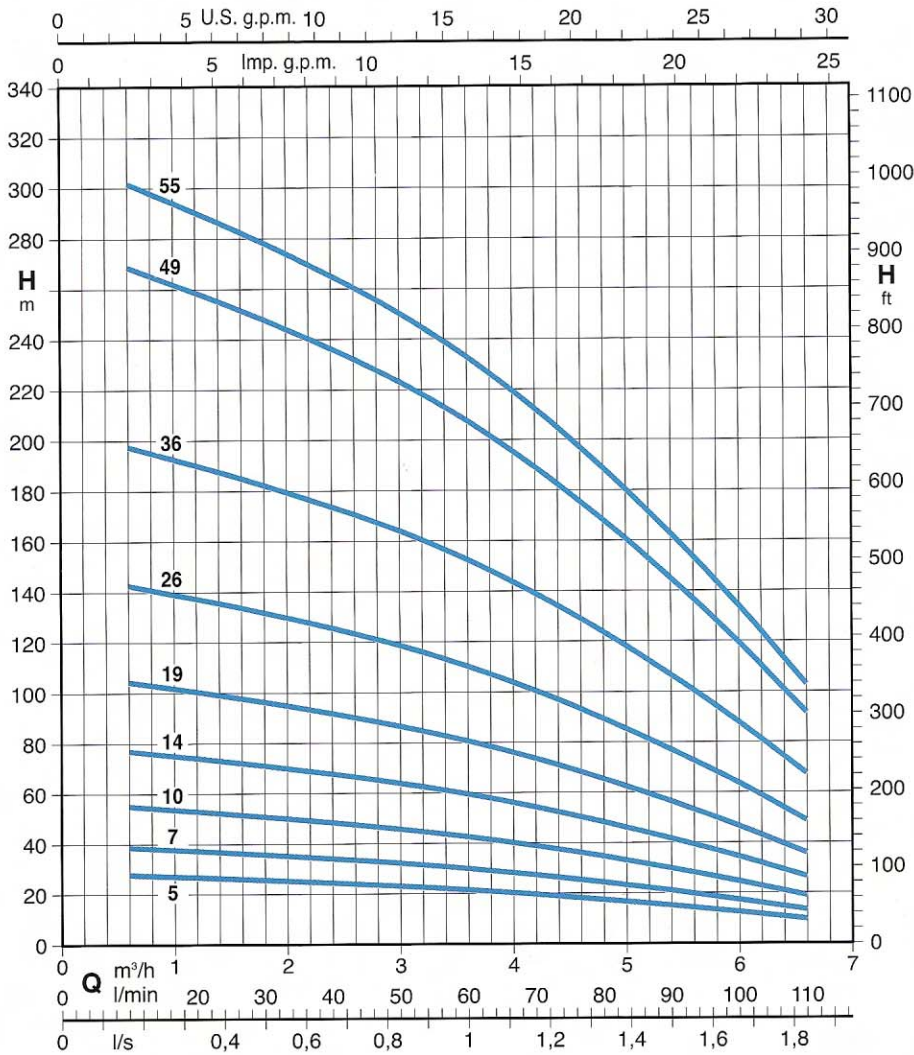

Supplied by:

Ernest Electro Engineering (Pty) Ltd.
ARMATURE & MOTOR REWINDING

370 Kruger Road, Strijdom Park, Randburg, South Africa

Tel: (011) 792 9550 / 1 / 2 Fax: (011) 792 9553

E-mail: eeaman@mweb.co.za Website: ernestee.co.za

TYPE	P ₂		Q	n ≈ 2900 1/min													
				m ³ /h		H											
				0	0,6	1,2	1,8	2,4	3	3,6	4,2	4,8	5,4	6	6,6		
	kW	HP	0	10	20	30	40	50	60	70	80	90	100	110			
PM 45-5	0,37	0,5		28,4	27,4	26,4	25,3	24,1	22,7	21,1	19,3	17,1	14,7	12,2	9,3		
PM 45-7	0,55	0,75		39,7	38,3	36,9	35,4	33,7	31,8	29,6	27	24	20,6	17	13		
PM 45-10	0,75	1		56,8	54,8	52,7	50,5	48,2	45,5	42,3	38,5	34,2	29,5	24,3	18,6		
PM 45-14	1,1	1,5		79,5	76,7	73,8	70,7	67,4	63,7	59,2	53,9	47,9	41,3	34,1	26,1		
PM 45-19	1,5	2		108	104	100	96	91,5	86,4	80,3	73,2	65,1	56	46,2	35,4		
PM 45-26	2,2	3		148	142	137	131	125	118	110	100	89	76,7	63,2	48,4		
PM 45-36	3	4		204	197	190	182	173	164	152	139	123	106	87,6	67		
PM 45-49	4	5,5		278	268	258	248	236	223	207	189	168	145	119	91,2		
PM 45-55	5,5	7,5		312	301	290	278	265	250	233	212	188	162	134	102		

OT - IM		IS	
L	kg	L	kg
mm	kg	mm	kg
335	3,1	365	2,3
395	3,5	425	2,7
485	4,2	515	3,4
610	5,0	640	4,2
760	6,1	790	5,3
970	7,4	1000	6,6
1325	9,8	1355	9,0
1715	12,8	1745	12,0
2085	14,2	2115	13,4

PM55

4" SUBMERSIBLE PUMPS

ERNEST ELECTRO PUMPS

50 Hz - n = 2900 rpm

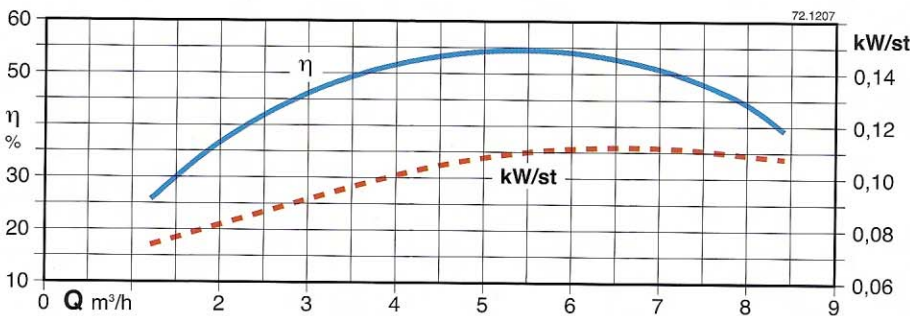
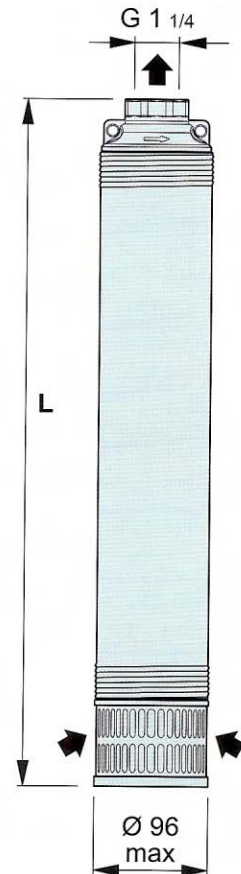
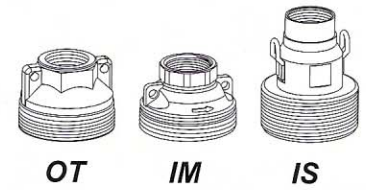
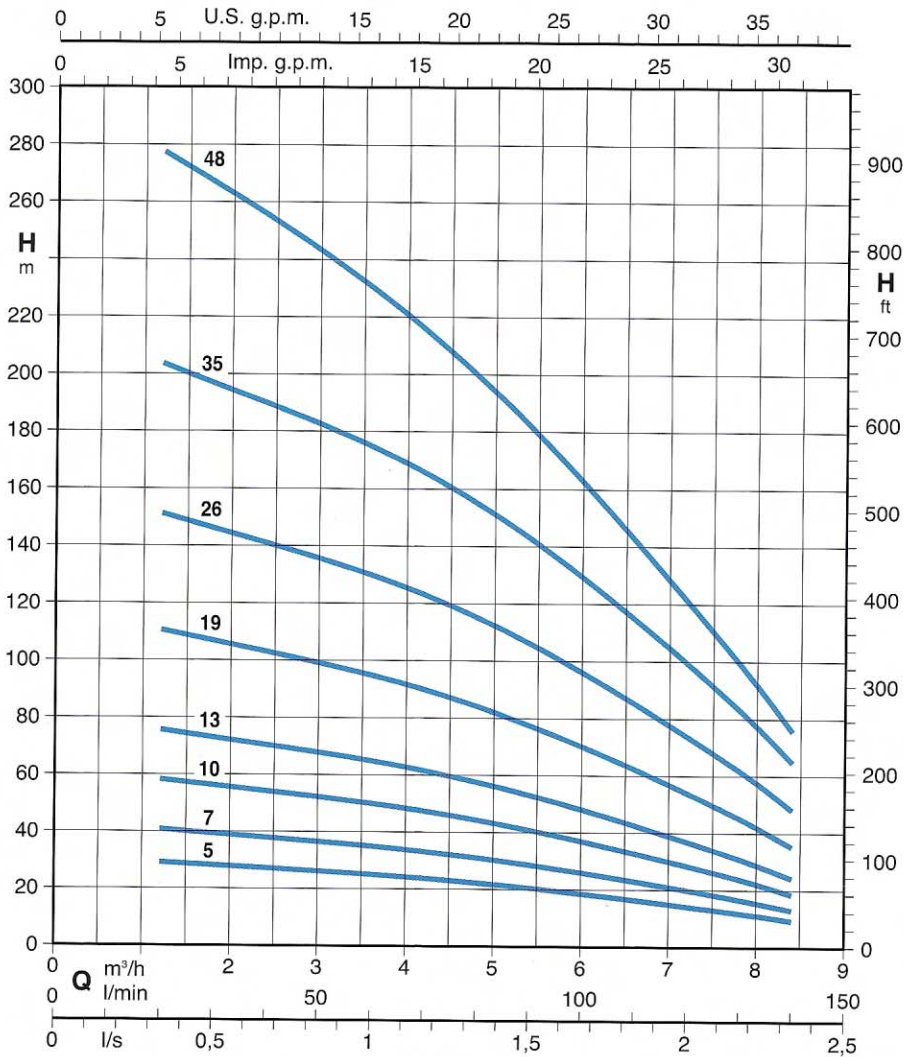

Supplied by:

Ernest Electro Engineering (Pty) Ltd.
ARMATURE & MOTOR REWINDING

370 Kruger Road, Strijdom Park, Randburg, South Africa
 Tel: (011) 792 9550 / 1 / 2 Fax: (011) 792 9553
 E-mail: eeaman@mweb.co.za Website: ernestee.co.za

TYPE	P ₂		Q	n ≈ 2900 1/min											
				m³/h											
	kW	HP		0	1,2	1,8	2,4	3,0	3,6	4,2	4,8	5,4	6,0	7,2	8,4
PM 55-5	0,55	0,75	31	29,1	28,1	27,1	26,1	24,9	23,6	22,1	20,4	18,5	14,2	9,2	
PM 55-7	0,75	1	43,5	40,7	39,3	37,9	36,5	34,9	33,1	31,0	28,5	25,8	19,9	12,9	
PM 55-10	1,1	1,5	62,1	58,1	56,1	54,1	52,1	49,9	47,3	44,2	40,8	36,9	28,4	18,4	
PM 55-13	1,5	2	80,7	75,6	73	70,4	67,7	64,8	61,4	57,5	53	48	36,9	24	
PM 55-19	2,2	3	118	110	107	103	99	94,7	89,8	84,1	77,5	70,1	53,9	35	
PM 55-26	3	4	161	151	146	141	135	130	123	115	106	96	73,7	48	
PM 55-35	4	5,5	217	203	196	190	182	174	165	155	143	129	99,3	64,6	
PM 55-48	5,5	7,5	298	277	266	255	243	230	215	199	182	163	121	75,5	

OT - IM		IS	
L		L	
mm	kg	mm	kg
335	3,1	365	2,3
395	3,5	425	2,7
485	4,2	515	3,4
580	4,8	610	4,0
765	6,1	795	5,3
970	7,6	1000	6,8
1300	9,5	1330	8,7
1690	11,6	1720	10,8

PM85

4" SUBMERSIBLE PUMPS

ERNEST ELECTRO PUMPS

50 Hz - n = 2900 rpm

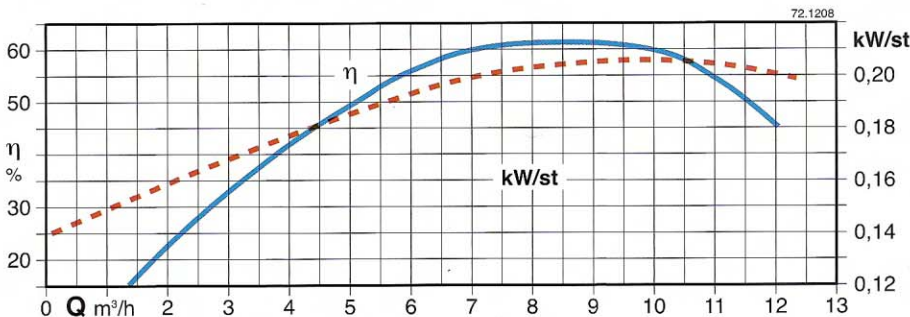
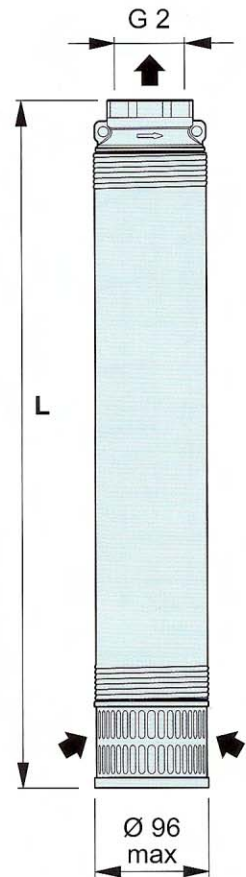
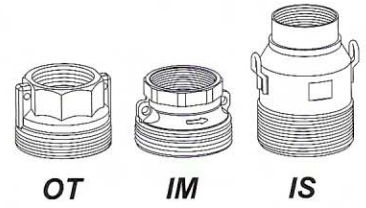
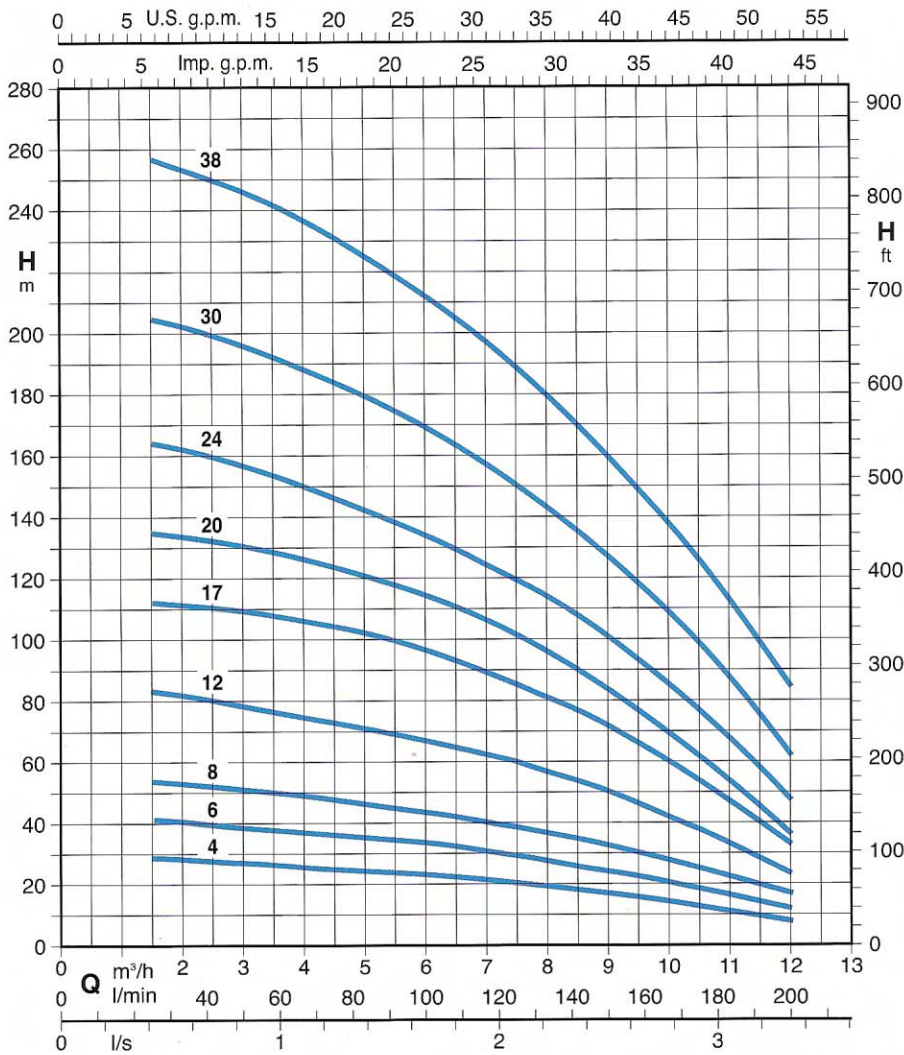

Supplied by:

Ernest Electro Engineering (Pty) Ltd.
ARMATURE & MOTOR REWINDING

370 Kruger Road, Strijdom Park, Randburg, South Africa
 Tel: (011) 792 9550 / 1 / 2 Fax: (011) 792 9553
 E-mail: eeaman@mweb.co.za Website: ernestee.co.za

TYPE	P ₂		Q	n ≈ 2900 1/min											
				m³/h											
				0	1,5	3,0	4,5	6,0	7,5	8,25	9,0	9,75	10,5	11,25	12,0
kW		HP	l/min	0	25	50	75	100	125	137,5	150	162,5	175	187,5	200
PM 85-4	0,75	1	H m	27,8	27,1	26	24,5	22,5	19,9	18,4	16,7	14,8	12,6	10,3	7,9
PM 85-6	1,1	1,5		41,7	40,6	39	36,8	33,7	29,9	27,6	25,1	22,2	19	15,5	11,8
PM 85-8	1,5	2		55,6	54,2	52,1	49	45	39,9	36,8	33,4	29,6	25,3	20,6	15,8
PM 85-12	2,2	3		83,4	81,2	78,1	73,5	67,5	59,8	55,3	50,1	44,3	37,9	31	23,6
PM 85-17	3	4		118	115	111	104	95,6	84,8	78,3	71	62,8	53,7	43,8	33,5
PM 85-20	3,7	5		139	135	130	123	112	99,7	92,1	83,5	73,9	63,2	51,6	39,4
PM 85-24	4	5,5		167	162	156	147	135	120	111	100	88,7	75,9	61,9	47,3
PM 85-30	5,5	7,5		208	203	195	184	169	150	138	125	111	94,8	77,4	59,1
PM 85-38	7,5	10		264	257	247	233	214	189	175	159	140	120	98	74,9

OT - IM		IS	
L		L	
mm	kg	mm	kg
410	3,7	460	2,9
515	4,5	565	3,7
620	5,3	670	4,5
830	6,9	880	6,1
1095	8,9	1145	8,1
1310	10,3	1360	9,5
1520	11,9	1570	11,1
1840	14,4	1890	13,6
2260	17,6	2310	16,8

PM140

4" SUBMERSIBLE PUMPS

ERNEST ELECTRO PUMPS

50 Hz - n = 2900 rpm

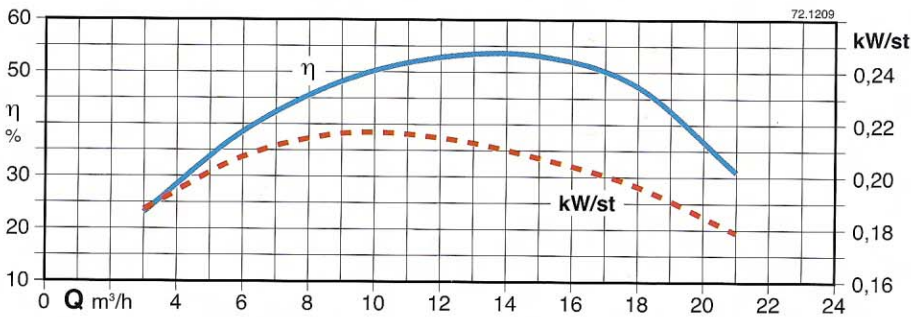
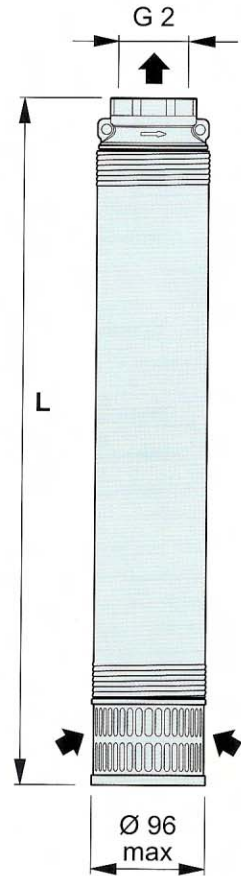
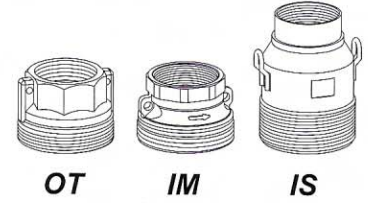
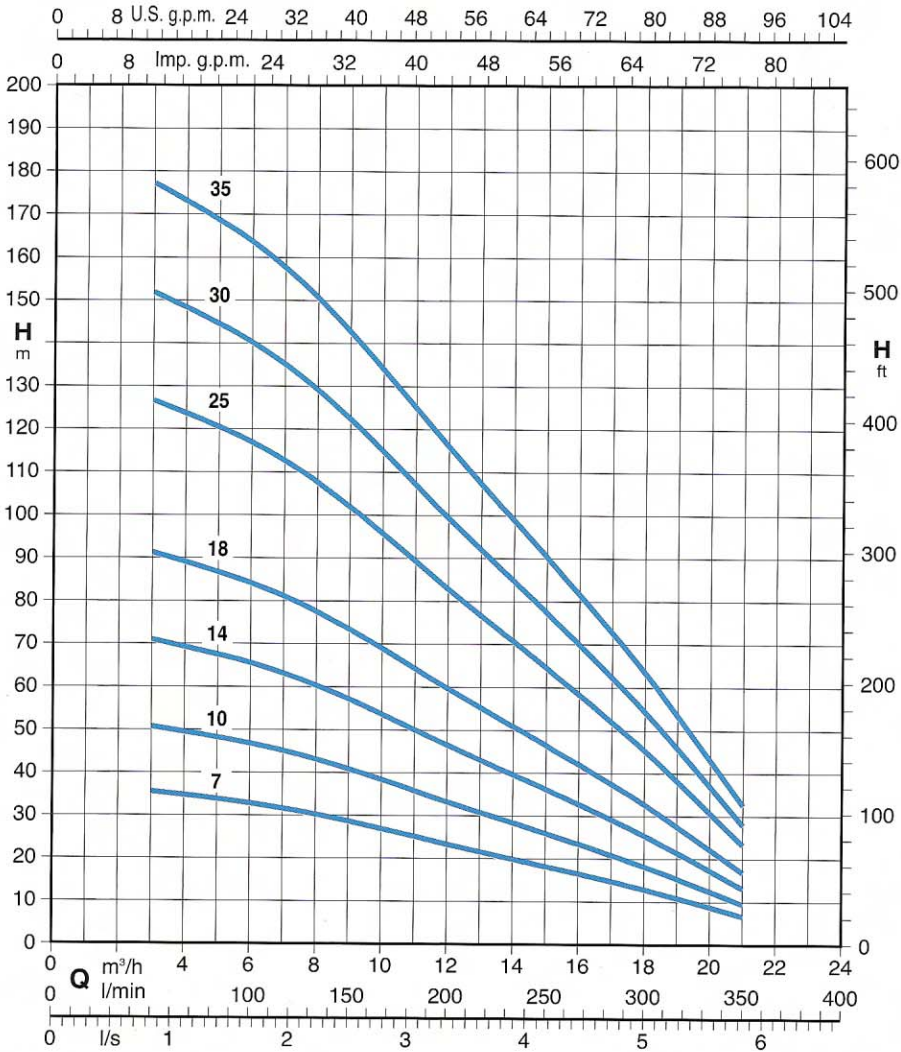

Supplied by:

Ernest Electro Engineering (Pty) Ltd.
ARMATURE & MOTOR REWINDING

370 Kruger Road, Strijdom Park, Randburg, South Africa
 Tel: (011) 792 9550 / 1 / 2 Fax: (011) 792 9553
 E-mail: eeaman@mweb.co.za Website: ernestee.co.za

TYPE	P ₂		Q	n ≈ 2900 1/min												
				m ³ /h												
				0	3,0	4,5	6,0	7,5	9,0	10,5	12,0	13,5	15,0	18,0	21,0	
	kW	HP	l/min	0	50	75	100	125	150	175	200	225	250	300	350	
PM 140-7	1,5	2	H m	40	37,2	35,8	34,3	32,4	29,9	27,1	24,3	21,6	18,9	13,3	6,8	
PM 140-10	2,2	3		57,2	53,1	51,2	49	46,2	42,7	38,8	34,7	30,8	27	19	9,7	
PM 140-14	3	4		80	74,3	71,6	68,6	64,7	59,8	54,3	48,6	43,2	37,8	26,6	13,6	
PM 140-18	4	5,5		103	95,6	92,1	88,2	83,2	76,9	69,8	62,5	55,5	48,7	34,1	17,5	
PM 140-25	5,5	7,5		143	133	128	123	116	107	96,9	86,8	77,1	67,6	47,4	24,3	
PM 140-30	7,5	10		171	159	153	147	139	128	116	104	92,5	81,1	56,9	29,1	
PM 140-35	7,5	10		200	186	179	172	162	150	136	122	108	94,6	66,4	34	

OT - IM		IS	
L		L	
mm	kg	mm	kg
760	5,9	810	4,5
990	8,0	1040	6,6
1375	10,4	1415	9,0
1680	13,2	1730	12,4
2295	18,1	2345	17,3
2685	21,3	2735	20,5
3075	24,8	3125	24,0

SF-16

4" SUBMERSIBLE PUMPS
SAND-RESISTANT

ERNEST ELECTRO PUMPS

50 Hz - $n \approx 2900$ rpm

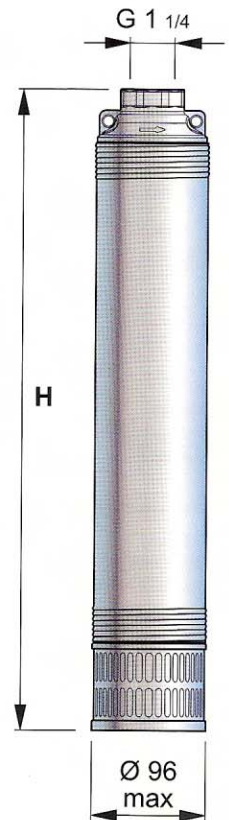
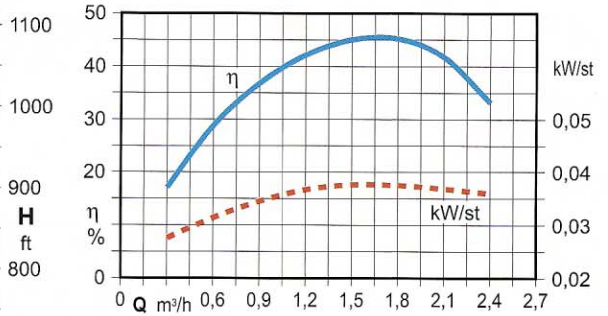
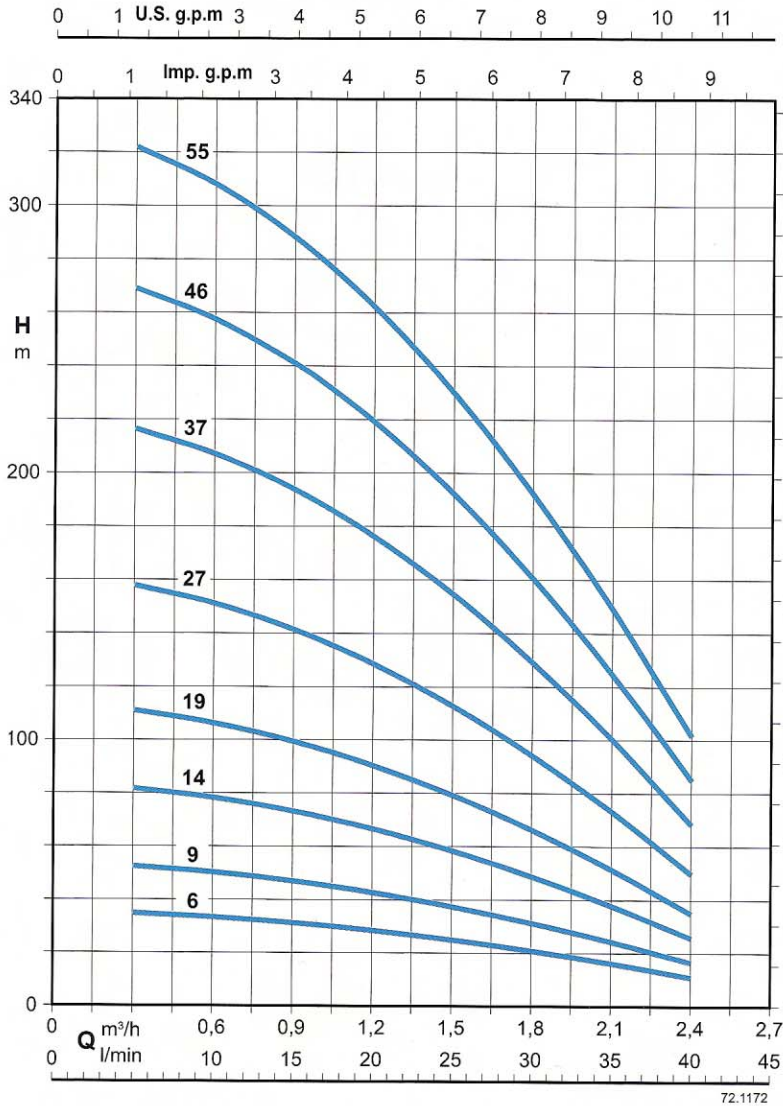

Supplied by:

Ernest Electro Engineering (Pty) Ltd.
ARMATURE & MOTOR REWINDING

370 Kruger Road, Strijdom Park, Randburg, South Africa
Tel: (011) 792 9550 / 1 / 2 Fax: (011) 792 9553
E-mail: eeeaman@mweb.co.za Website: ernestee.co.za

TYPE	STAGES N.	MOTOR		Q m³/h l/min	DELIVERY														BRASS		S.STEEL	
		kW	HP																H mm	kg	H mm	kg
					0	0,3	0,6	0,9	1,05	1,2	1,35	1,5	1,65	1,8	1,95	2,1	2,25	2,4				
SF-16/6	6	0,25	0,33	36,1	35,1	33,6	31,5	30,1	28,6	26,9	25,1	23,1	21,0	18,7	16,3	13,7	11,1	305	3,30	305	2,80	
SF-16/9	9	0,37	0,5	54,2	52,7	50,4	47,2	45,2	42,9	40,4	37,6	34,6	31,4	28,0	24,4	20,6	16,6	365	3,80	365	3,30	
SF-16/14	14	0,55	0,75	84,3	82,0	78,5	73,4	70,3	66,8	62,8	58,5	53,9	48,9	43,6	38,0	32,1	25,8	465	4,70	465	4,20	
SF-16/19	19	0,75	1	114	111	106	100	95,4	90,6	85,3	79,5	73,1	66,4	59,2	51,5	43,5	35,1	565	5,70	565	5,20	
SF-16/27	27	1,1	1,5	163	158	151	142	136	129	121	113	104	94,3	84,1	73,2	61,8	49,8	725	7,20	725	6,70	
SF-16/37	37	1,5	2	223	217	207	194	186	176	166	155	142	129	115	100	84,7	68,3	915	9,10	915	8,60	
SF-16/46	46	2,2	3	277	269	258	241	231	219	206	192	177	161	143	125	105	84,9	1095	10,80	1095	10,30	
SF-16/55	55	2,2	3	331	322	308	288	276	262	247	230	212	192	171	149	126	102	1325	12,85	1325	12,35	

SF-22

4" SUBMERSIBLE PUMPS
SAND-RESISTANT

ERNEST ELECTRO PUMPS

50 Hz - $n \approx 2900$ rpm

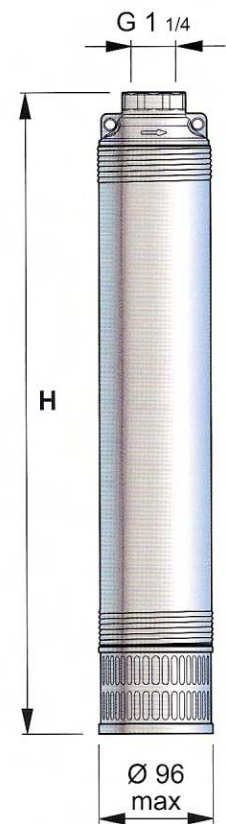
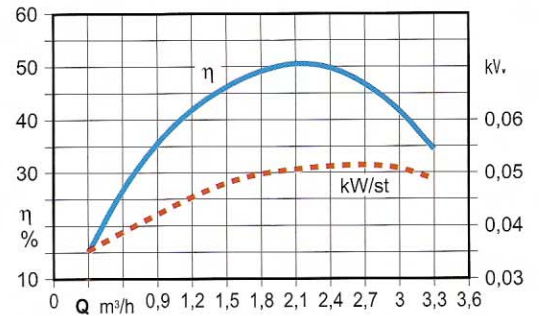
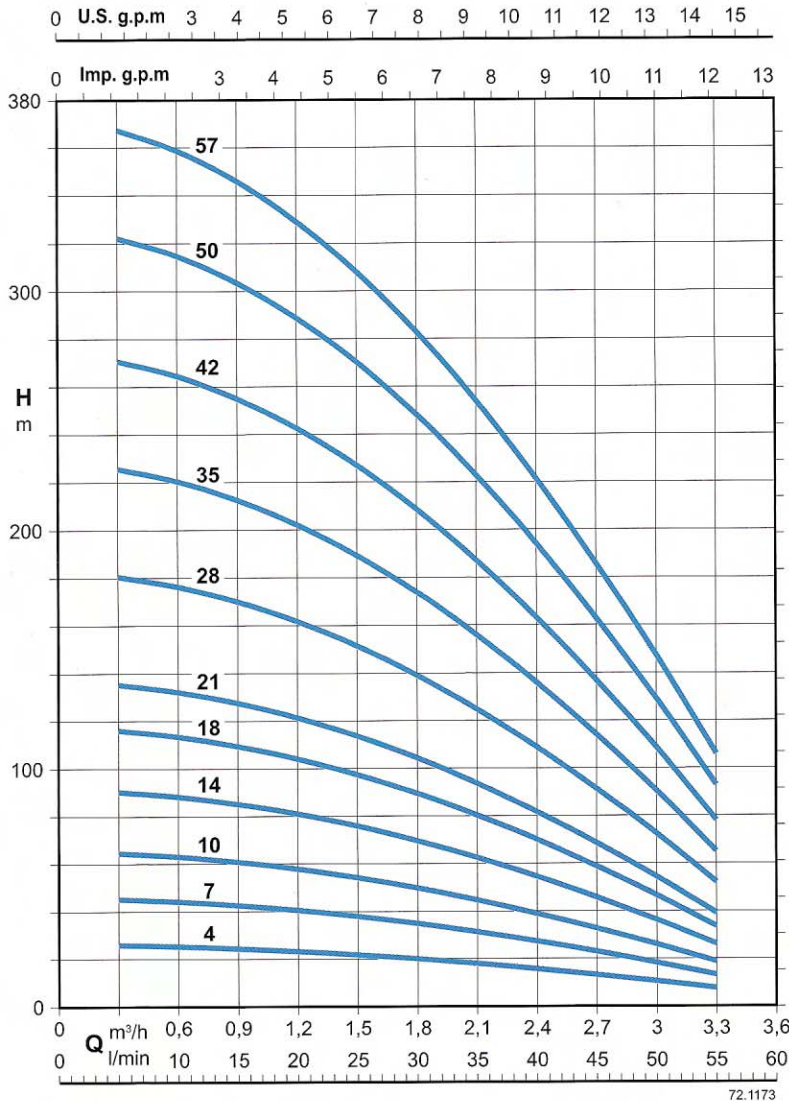

Supplied by:

Ernest Electro Engineering (Pty) Ltd.
ARMATURE & MOTOR REWINDING

370 Kruger Road, Strijdom Park, Randburg, South Africa
Tel: (011) 792 9550 / 1 / 2 Fax: (011) 792 9553
E-mail: eeeaman@mweb.co.za Website: ernestee.co.za

TYPE	STAGES N.	MOTOR		Q m³/h l/min	DELIVERY -																BRASS		S.STEEL				
		kW	HP		H m HEAD																H mm	kg	H mm	kg			
					0	0,3	0,6	0,9	1,2	1,5	1,8	1,95	2,1	2,25	2,4	2,7	3	3,3	0	5	10	15	20	25	30	32,5	35
SF-22/4	4	0,25	0,33	26,1	25,8	25,2	24,3	23,1	21,6	19,8	18,9	17,8	16,7	15,5	13,0	10,3	7,4	265	2,90	265	2,40						
SF-22/7	7	0,37	0,5	45,6	45,1	44,0	42,5	40,4	37,8	34,7	33,0	31,2	29,2	27,1	22,8	18,0	13,0	325	3,45	325	2,95						
SF-22/10	10	0,55	0,75	65,2	64,4	62,9	60,7	57,7	54,0	49,6	47,1	44,5	41,7	38,8	32,5	25,8	18,5	385	4,00	385	3,50						
SF-22/14	14	0,75	1	91,2	90,2	88,1	84,9	80,8	75,6	69,5	66,0	62,3	58,4	54,3	45,5	36,1	25,9	465	4,70	465	4,20						
SF-22/18	18	1,1	1,5	117	116	113	109	104	97,2	89,3	84,9	80,1	75,1	69,8	58,5	46,4	33,4	545	5,50	545	5,00						
SF-22/21	21	1,1	1,5	137	135	132	127	121	113	104	99,0	93,5	87,6	81,4	68,3	54,1	38,9	605	6,05	605	5,55						
SF-22/28	28	1,5	2	182	180	176	170	162	151	139	132	125	117	109	91,1	72,2	51,9	745	7,40	745	6,90						
SF-22/35	35	2,2	3	228	225	220	212	202	189	174	165	156	146	136	114	90,2	64,9	885	8,70	885	8,20						
SF-22/42	42	2,2	3	274	271	264	255	242	227	208	198	187	175	163	137	108	77,8	1015	10,05	1015	9,55						
SF-22/50	50	3	4	326	322	315	303	289	270	248	236	223	209	194	163	129	92,7	1175	11,55	1175	11,05						
SF-22/57	57	3	4	371	367	359	346	329	308	283	269	254	238	221	185	147	106	1365	13,20	1365	12,70						

SF-36

4" SUBMERSIBLE PUMPS
SAND-RESISTANT

ERNEST ELECTRO PUMPS

50 Hz - n ≈ 2900 rpm

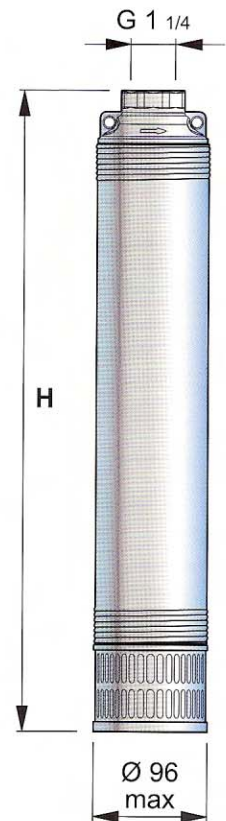
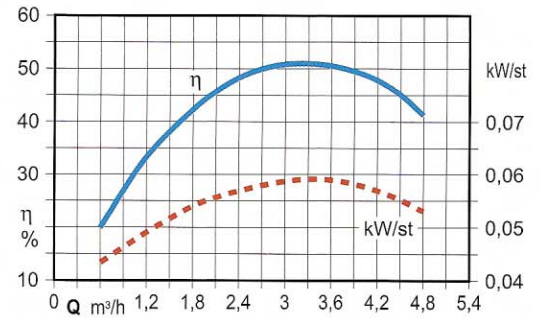
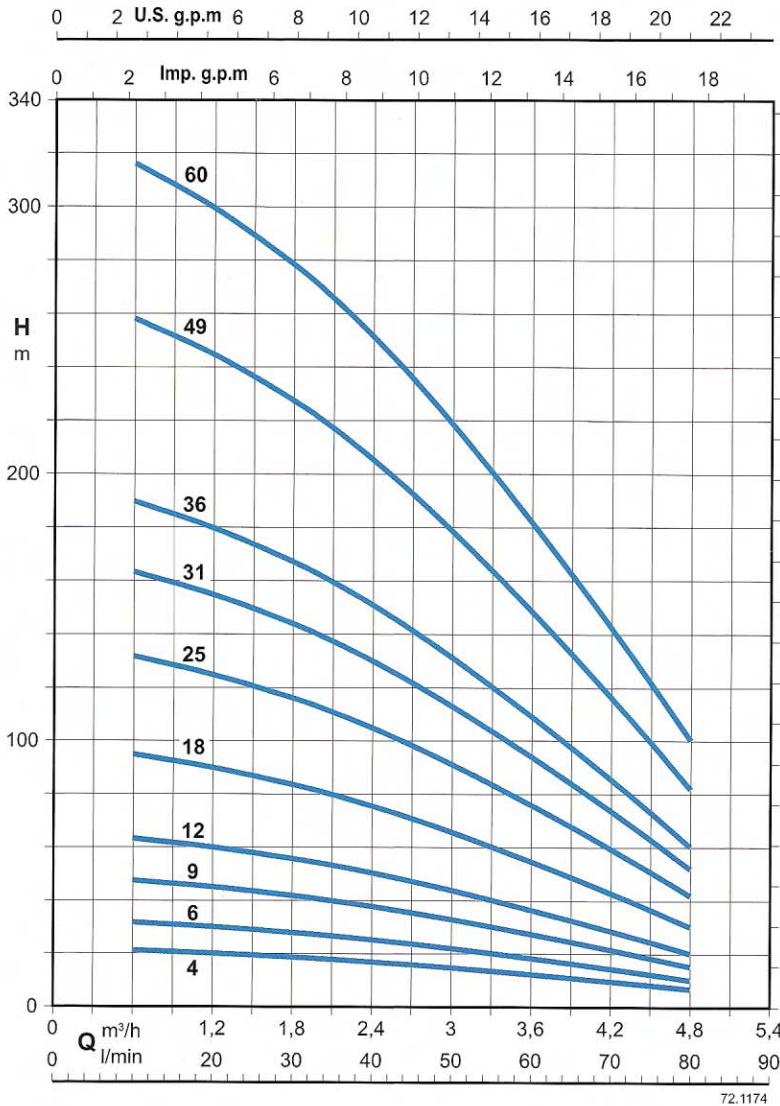

Supplied by:
Ernest Electro Engineering (Pty) Ltd.
ARMATURE & MOTOR REWINDING

370 Kruger Road, Strijdom Park, Randburg, South Africa
Tel: (011) 792 9550 / 1 / 2 Fax: (011) 792 9553
E-mail: eeeman@mweb.co.za Website: ernestee.co.za

TYPE	STAGES N.	MOTOR		Q m³/h l/min	DELIVERY														BRASS		S.STEEL	
		kW	HP		0	0,6	1,2	1,8	2,1	2,4	2,7	3	3,3	3,6	3,9	4,2	4,5	4,8	H mm	kg	H mm	kg
					0	10	20	30	35	40	45	50	55	60	65	70	75	80				
SF-36/4	4	0,25	0,33	H m HEAD	22	21,1	20	18,6	17,7	16,8	15,7	14,6	13,4	12,1	10,8	9,5	8,1	6,7	290	3,00	290	2,50
SF-36/6	6	0,37	0,5		33	31,6	29,9	27,8	26,6	25,1	23,6	21,9	20,1	18,2	16,2	14,2	12,2	10	340	3,40	340	2,90
SF-36/9	9	0,55	0,75		49,5	47,4	44,9	41,8	39,9	37,7	35,3	32,8	30,1	27,3	24,4	21,4	18,3	15	420	4,10	420	3,60
SF-36/12	12	0,75	1		66	63,2	59,9	55,7	53,1	50,3	47,1	43,7	40,1	36,3	32,5	28,5	24,3	20	500	4,75	500	4,25
SF-36/18	18	1,1	1,5		99	94,8	89,8	83,5	79,7	75,4	70,7	65,6	60,2	54,5	48,7	42,7	36,5	30	660	6,05	660	5,55
SF-36/25	25	1,5	2		137	132	125	116	111	105	98,2	91,1	83,6	75,7	67,7	59,3	50,7	41,7	845	7,60	845	7,10
SF-36/31	31	2,2	3		170	163	155	144	137	130	122	113	104	93,9	83,9	73,6	62,9	51,7	1005	8,90	1005	8,40
SF-36/36	36	2,2	3		198	190	180	167	159	151	141	131	120	109	97,4	85,4	73	60,1	1135	10,00	1135	9,50
SF-36/49	49	3	4		269	258	245	227	217	205	192	178	164	148	133	116	99,4	81,8	1530	13,20	1530	12,70
SF-36/60	60	4	5,5		330	316	299	278	266	251	236	219	201	182	162	142	122	100	1820	15,60	1820	15,10

SF-46

4" SUBMERSIBLE PUMPS
SAND-RESISTANT

ERNEST ELECTRO PUMPS

50 Hz - n ≈ 2900 rpm

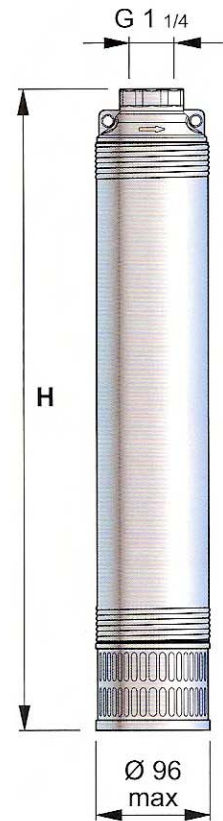
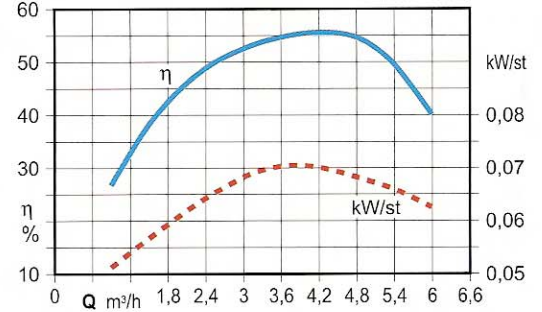
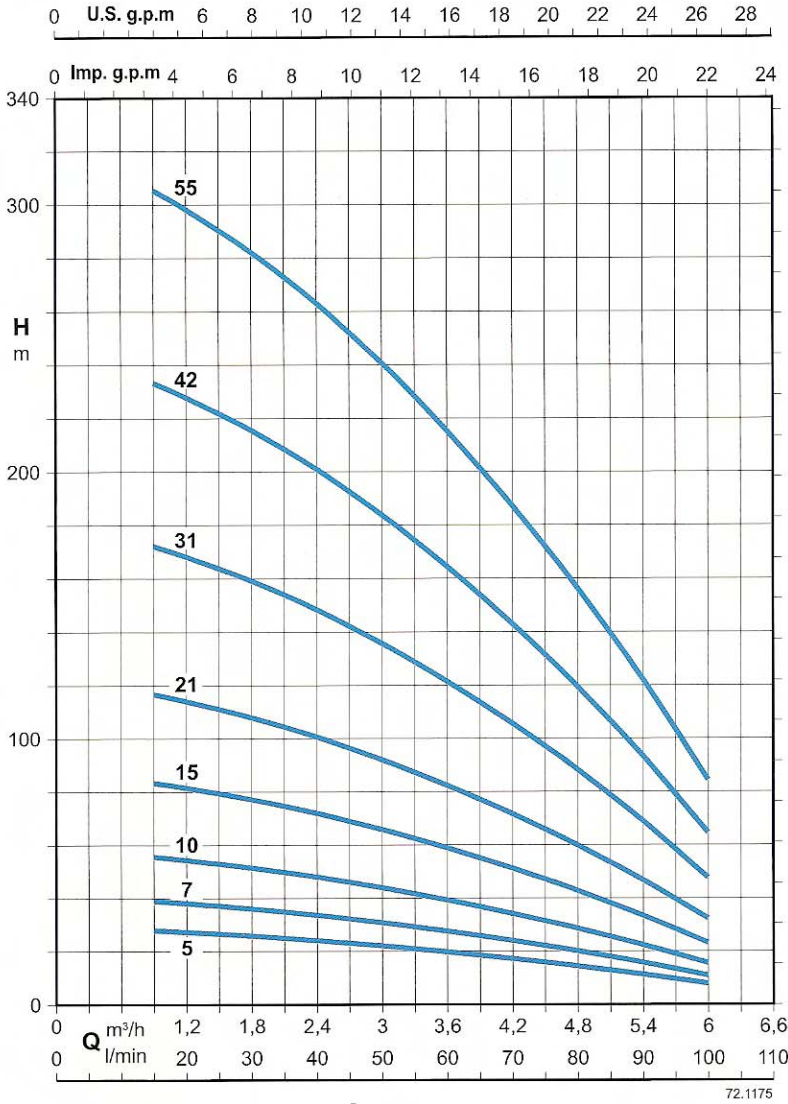

Supplied by:

Ernest Electro Engineering (Pty) Ltd.
ARMATURE & MOTOR REWINDING

370 Kruger Road, Strijdom Park, Randburg, South Africa
Tel: (011) 792 9550 / 1 / 2 Fax: (011) 792 9553
E-mail: eeaman@mweb.co.za Website: ernestee.co.za

TYPE	STAGES N.	MOTOR		Q m³/h l/min	DELIVERY																BRASS		S.STEEL	
		kW	HP		H m HEAD																H mm	kg	H mm	kg
					0	0,9	1,2	1,8	2,4	3	3,3	3,6	3,9	4,2	4,5	4,8	5,4	6						
SF-46/5	5	0,37	0,5	29,4	27,8	27,1	25,6	23,9	21,9	20,7	19,6	18,3	17,0	15,6	14,2	11,1	7,6	315	3,20	315	2,70			
SF-46/7	7	0,55	0,75	41,2	38,9	37,9	35,9	33,5	30,6	29,0	27,4	25,6	23,8	21,9	19,9	15,5	10,7	370	3,65	370	3,15			
SF-46/10	10	0,75	1	58,9	55,5	54,2	51,3	47,8	43,7	41,5	39,1	36,6	34,0	31,3	28,4	22,2	15,3	450	4,30	450	3,80			
SF-46/15	15	1,1	1,5	88,3	83,3	81,3	76,9	71,7	65,6	62,2	58,7	54,9	51,0	46,9	42,6	33,3	22,9	585	5,40	585	4,90			
SF-46/21	21	1,5	2	124	117	114	108	100	91,9	87,1	82,2	76,9	71,4	65,7	59,6	46,6	32,1	740	6,70	740	6,20			
SF-46/31	31	2,2	3	183	172	168	159	148	136	129	121	114	105	96,9	88,0	68,8	47,4	1005	8,90	1005	8,40			
SF-46/42	42	3	4	247	233	228	215	201	184	174	164	154	143	131	119	93,2	64,2	1340	11,70	1340	11,20			
SF-46/55	55	4	5,5	324	305	298	282	263	241	228	215	201	187	172	156	122	84,1	1685	14,50	1685	14,00			

SF-54

4" SUBMERSIBLE PUMPS
SAND-RESISTANT

ERNEST ELECTRO PUMPS

50 Hz - $n \approx 2900$ rpm

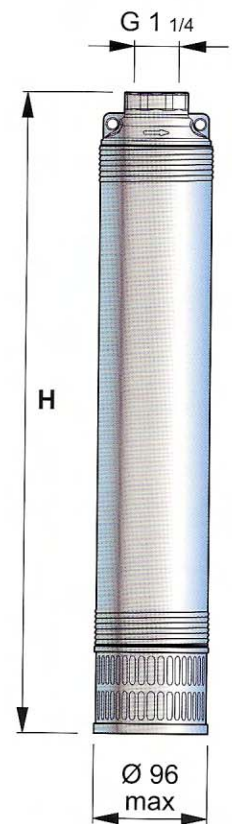
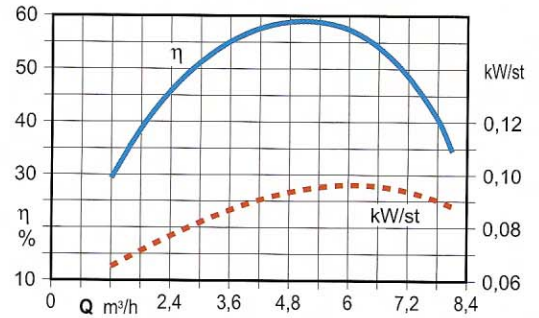
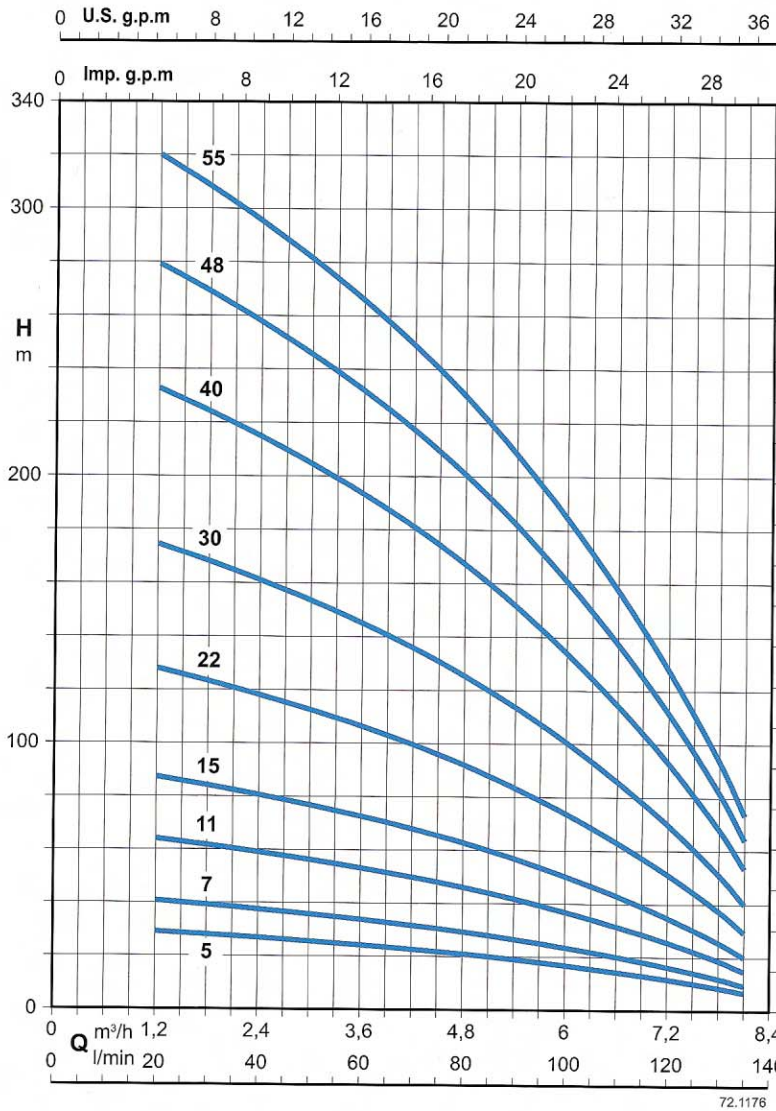

Supplied by:
Ernest Engineering (Pty) Ltd.
 ARMATURE & MOTOR REWINDING

370 Kruger Road, Strijdom Park, Randburg, South Africa
 Tel: (011) 792 9550 / 1 / 2 Fax: (011) 792 9553
 E-mail: eeeaman@mweb.co.za Website: ernestee.co.za

TIPO TYPE TYPE	N. STADI STAGES N. N. ÉTAGE N. ETAPAS	MOTORE MOTOR MOTEUR		Q m³/h l/min	PORTATA - DELIVERY - DEBIT - CAUDAL													OTTONE BRASS LAITON LATON		INOX S.STEEL	
		kW	HP		H m HEAD													H mm	kg	H mm	kg
					0	1,2	1,8	2,4	3	3,6	4,2	4,8	5,4	6	6,6	7,2	7,8				
SF-54/5	5	0,55	0,75	30,8	29,1	28,0	26,8	25,6	24,2	22,6	20,9	18,9	16,8	14,3	11,6	8,5	6,6	340	3,20	340	2,70
SF-54/7	7	0,75	1	43,1	40,7	39,2	37,6	35,8	33,8	31,7	29,3	26,5	23,5	20,0	16,3	11,9	9,3	400	3,65	400	3,15
SF-54/11	11	1,1	1,5	67,7	64,0	61,6	59,1	56,3	53,2	49,8	46,0	41,7	36,9	31,5	25,6	18,7	14,6	520	4,60	520	4,10
SF-54/15	15	1,5	2	92,3	87,3	84,1	80,5	76,7	72,5	67,9	62,7	56,8	50,3	42,9	34,8	25,5	19,9	640	5,60	640	5,10
SF-54/22	22	2,2	3	135	128	123	118	113	106	99,6	92,0	83,4	73,7	63,0	51,1	37,4	29,2	850	7,25	850	6,75
SF-54/30	30	3	4	185	175	168	161	153	145	136	125	114	101	85,9	69,7	51,0	39,9	1090	9,20	1090	8,70
SF-54/40	40	4	5,5	246	233	224	215	205	193	181	167	152	134	115	92,9	68,0	53,1	1440	11,90	1440	11,40
SF-54/48	48	5,5	7,5	295	279	269	258	246	232	217	201	182	161	137	112	81,6	63,8	1680	13,80	1680	13,30
SF-54/55	55	5,5	7,5	338	320	308	295	281	266	249	230	208	184	157	128	93,5	73,1	1890	15,50	1890	15,00

CRX

Multi-Stage Submersible Clean Water Pumps

ERNEST ELECTRO PUMPS

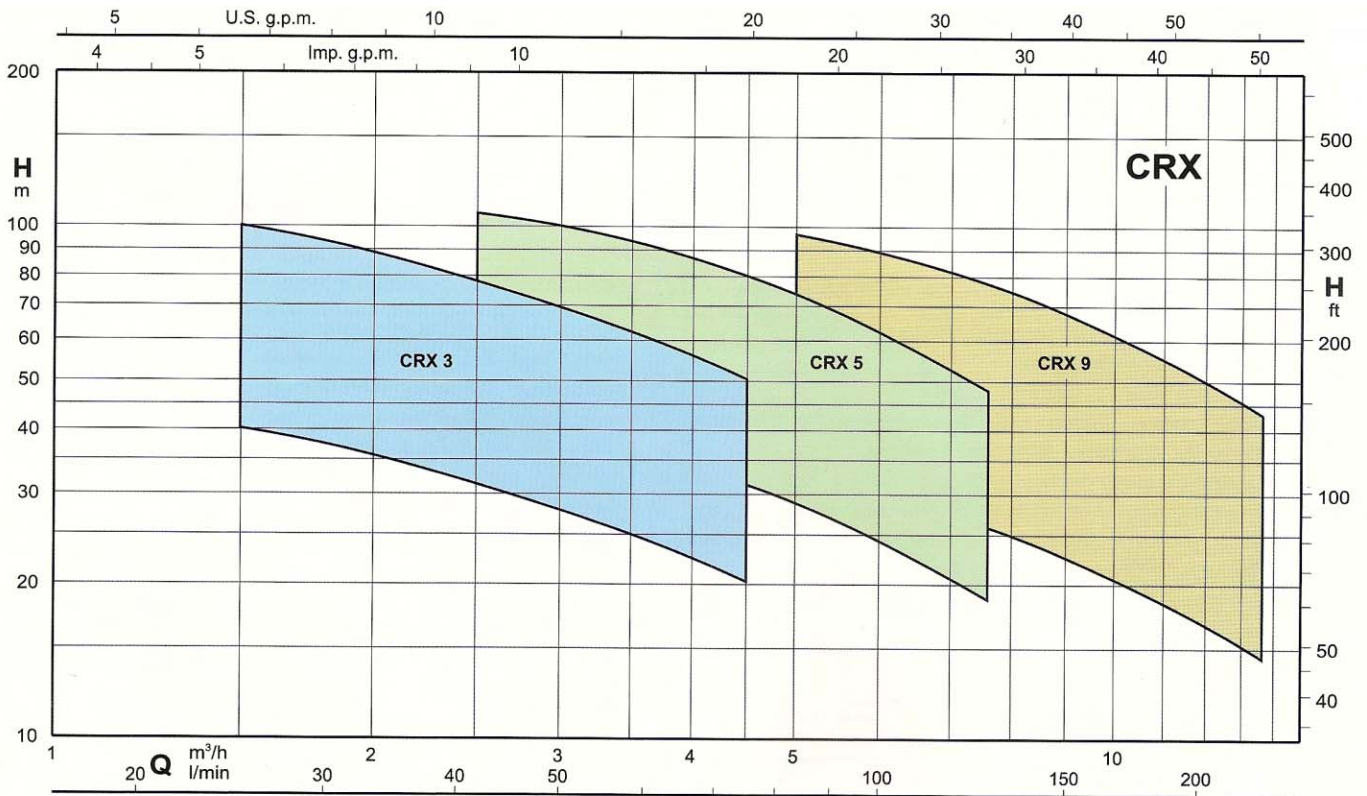

Supplied by:

ernest electro engineering (Pty) Ltd.
ARMATURE & MOTOR REWINDING

370 Kruger Road, Strijdom Park, Randburg, South Africa
Tel: (011) 792 9550 / 1 / 2 Fax: (011) 792 9553
E-mail: eeeaman@mweb.co.za Website: ernestee.co.za

CRX3

Multi-Stage Submersible
Clean Water Pumps

ERNEST ELECTRO PUMPS

50 Hz - $n \approx 2850$ rpm

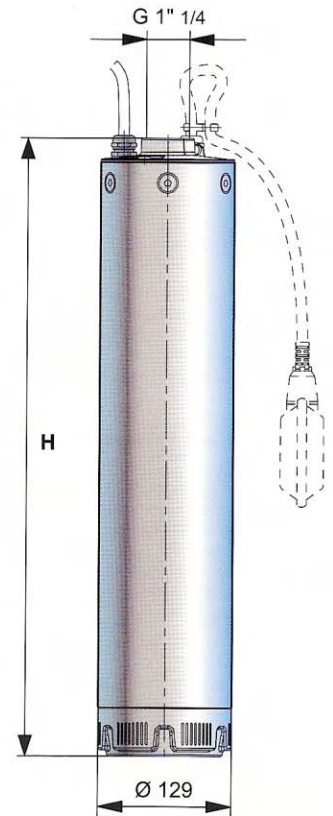
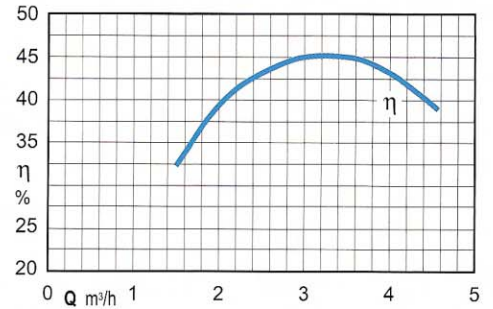
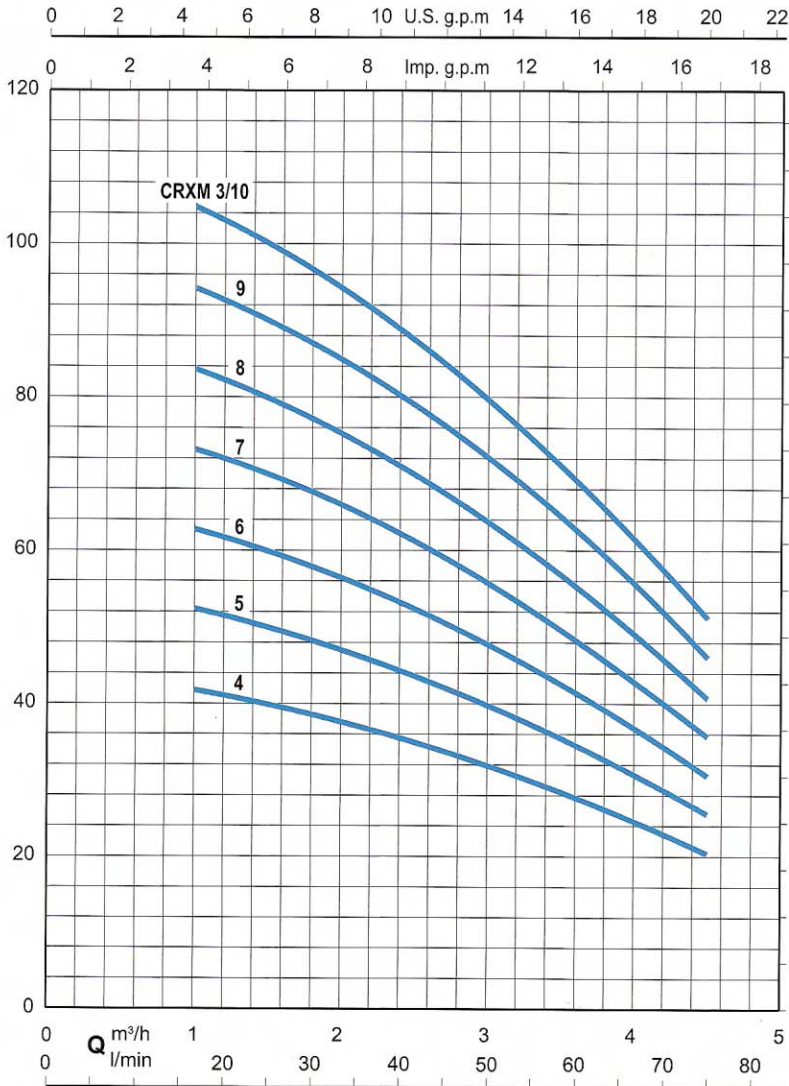

Supplied by:

Ernest Electro Engineering (Pty) Ltd.
ARMATURE & MOTOR REWINDING

370 Kruger Road, Strijdom Park, Randburg, South Africa
Tel: (011) 792 9550 / 1 / 2 Fax: (011) 792 9553
E-mail: eeeaman@mweb.co.za Website: ernestee.co.za

SINGLE-PHASE	Capacitor		THREE-PHASE		STAGES	MOTOR			Q m³/h l/min	DELIVERY										MONOPHASE SINGLE-PHASE MONOPHASE MONOFASICO		TRIFASE THREE-PHASE TRIFASE TRIFASICO	
	230 V	A	450 V	400 V		A	N.	kW		HP	P ₁	0	1,0	1,5	2	2,5	3,0	3,5	4,0	4,5	H mm	kg	H mm
CRXM 3/4	4,5	20	-	-	4	0,55	0,75	0,85	44,5	41,9	40	37,5	35	31,6	28,7	24,4	20,5	480	16,0	-	-		
CRXM 3/5	4,8	20	-	-	5	0,75	1	1	55,6	52,5	50	47	43,7	39,5	35,6	30,6	25,6	504	18,0	-	-		
CRXM 3/6	5,6	20	-	-	6	0,75	1	1,2	66,7	62,9	60	56,3	52,5	47,4	42,8	36,7	30,6	528	18,5	-	-		
CRXM 3/7	6,6	30	-	-	7	0,9	1,2	1,35	77,9	73,3	70	65,8	61,3	55,3	50	42,5	35,8	552	20,0	-	-		
CRXM 3/8	7,2	30	CRX 3/8	2,7	8	1,1	1,5	1,55	88,8	83,8	80	75	70	63	57,1	48,8	40,8	576	20,5	576	19,5		
CRXM 3/9	9	35	CRX 3/9	3	9	1,5	2	1,8	100	94,4	90	85	78,7	71	65,2	55	46,3	650	23,5	650	21,5		
CRXM 3/10	9,7	35	CRX 3/10	3,3	10	1,5	2	2	111	105	100	94,2	87,5	79	71,3	61,3	51,3	674	24,0	674	22,0		

CRX5

Multi-Stage Submersible
Clean Water Pumps

ERNEST ELECTRO PUMPS

50 Hz - $n \approx 2900$ rpm

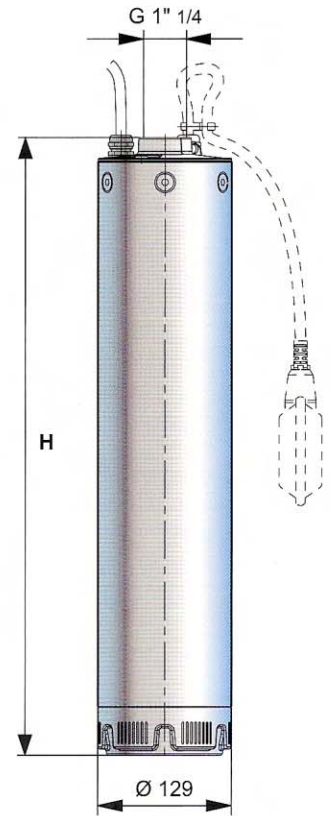
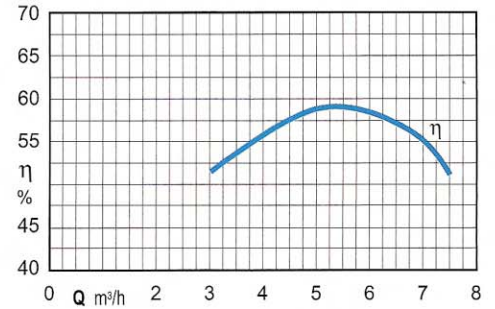
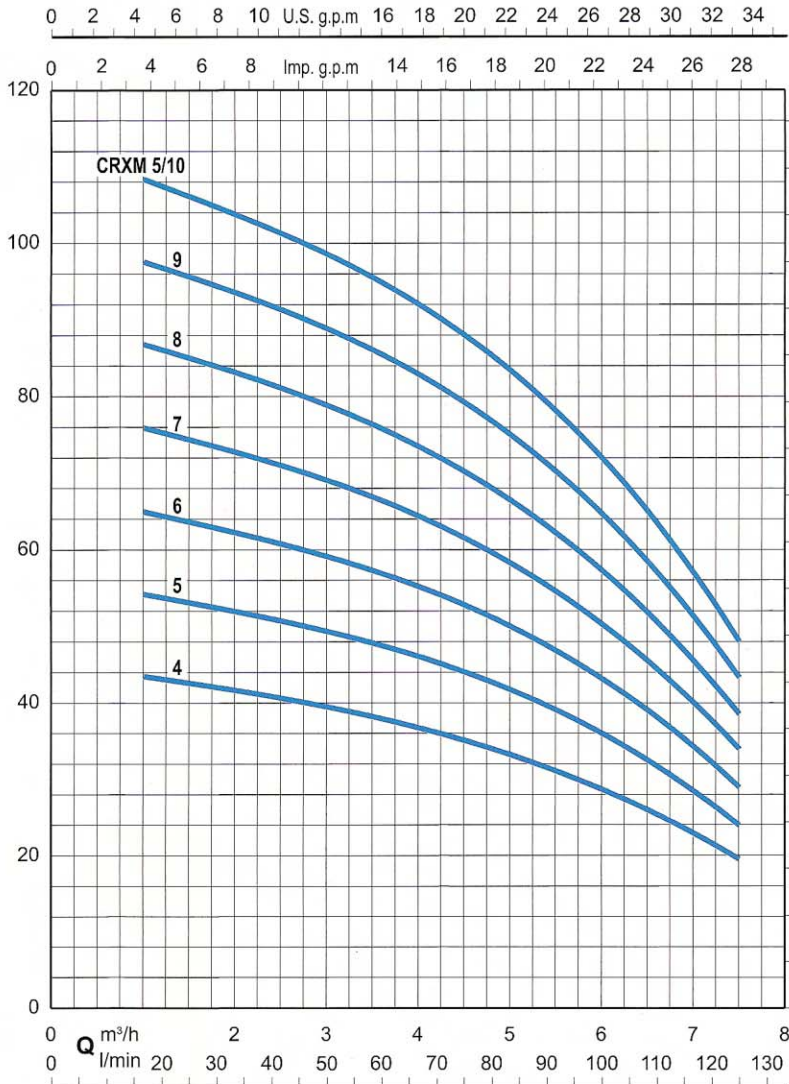

Supplied by:

Ernest Electro Engineering (Pty) Ltd.
ARMATURE & MOTOR REWINDING

370 Kruger Road, Strijdom Park, Randburg, South Africa
Tel: (011) 792 9550 / 1 / 2 Fax: (011) 792 9553
E-mail: eeeaman@mweb.co.za Website: ernestee.co.za

SINGLE-PHASE	Capacitor		THREE-PHASE	STAGES	MOTOR			Q	DELIVERY										SINGLE-PHASE		THREE-PHASE										
	230 V	A			450 V	400 V	A		N.	kW	HP	P1	m³/h	0	1	2	3	4	4,5	5	6	7,5	H mm	kg	H mm	kg					
CRXM 5/4	5,4	20	-	-	4	0,75	1	1,15	0	0	16,6	33,3	50	66,6	75	83,3	100	125	45	43,7	41,7	39,4	36,3	35	33,3	28,8	19,4	480	17,5	-	-
CRXM 5/5	6,5	30	-	-	5	0,9	1,2	1,4	0	16,6	33,3	50	66,6	75	83,3	100	125	45	43,7	41,7	39,4	36,3	35	33,3	28,8	19,4	504	19,0	-	-	
CRXM 5/6	7,6	30	CRX 5/6	2,8	6	1,1	1,5	1,65	0	16,6	33,3	50	66,6	75	83,3	100	125	45	43,7	41,7	39,4	36,3	35	33,3	28,8	19,4	528	19,5	528	18,5	
CRXM 5/7	9,5	35	CRX 5/7	3,3	7	1,5	2	1,95	0	16,6	33,3	50	66,6	75	83,3	100	125	45	43,7	41,7	39,4	36,3	35	33,3	28,8	19,4	602	22,5	602	20,5	
CRXM 5/8	10,5	35	CRX 5/8	3,5	8	1,5	2	2,2	0	16,6	33,3	50	66,6	75	83,3	100	125	45	43,7	41,7	39,4	36,3	35	33,3	28,8	19,4	626	23,0	626	21,0	
CRXM 5/9	11,7	45	CRX 5/9	4,8	9	2,2	3	2,4	0	16,6	33,3	50	66,6	75	83,3	100	125	45	43,7	41,7	39,4	36,3	35	33,3	28,8	19,4	650	25,0	650	23,5	
CRXM 5/10	12,7	45	CRX 5/10	5,1	10	2,2	3	2,65	0	16,6	33,3	50	66,6	75	83,3	100	125	45	43,7	41,7	39,4	36,3	35	33,3	28,8	19,4	674	25,5	674	24,0	

CRX9

Multi-Stage Submersible
Clean Water Pumps

ERNEST ELECTRO PUMPS

50 Hz - $n \approx 2900$ rpm

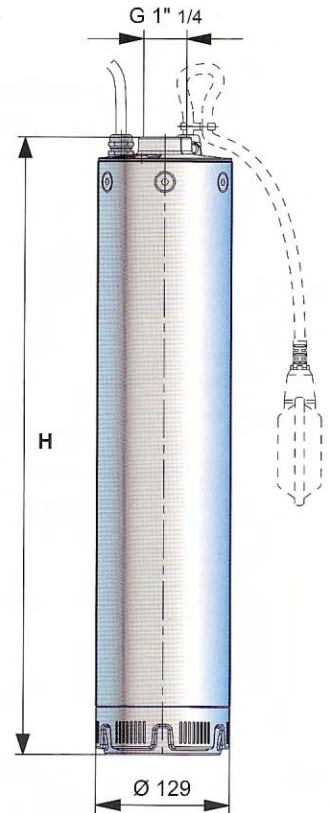
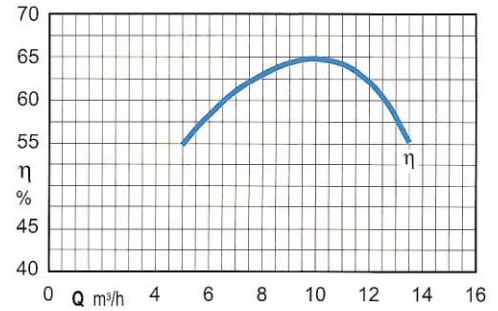
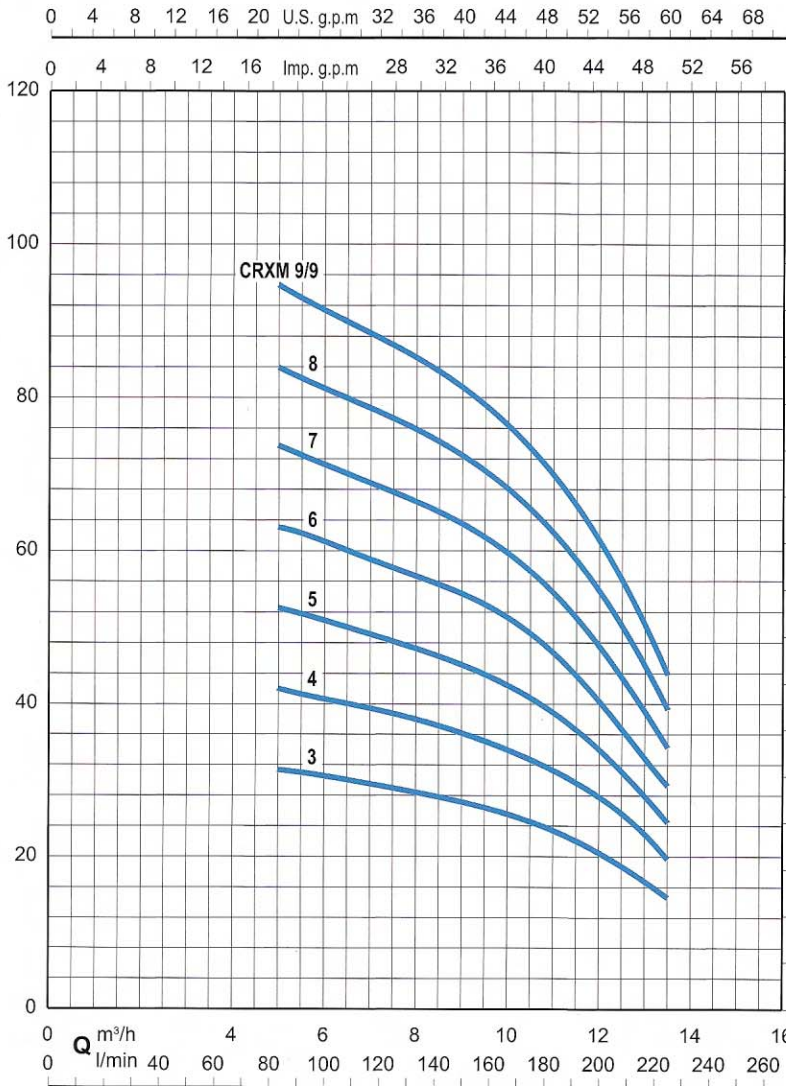

Supplied by:

Ernest Electro Engineering (Pty) Ltd.
ARMATURE & MOTOR REWINDING

370 Kruger Road, Strijdom Park, Randburg, South Africa
 Tel: (011) 792 9550 / 1 / 2 Fax: (011) 792 9553
 E-mail: eeeaman@mweb.co.za Website: ernestee.co.za

SINGLE-PHASE	Capacitor		THREE-PHASE		STAGES	MOTOR			Q m³/h l/min	DELIVERY									SINGLE-PHASE	THREE-PHASE		
	230 V	A	450 V	400 V		A	N.	kW		HP	P ₁	0	5,0	6,0	7,0	8,0	9,0	10,0		11,0	13,5	H mm
CRXM 9/3	6,7	30	-	-	3	1,1	1,5	1,4	H m HEAD	35	31,3	30,5	29,5	28,3	27,1	25,5	23,3	14,6	504	18,5	-	-
CRXM 9/4	9,5	35	CRX 9/4	3,2	4	1,5	2	1,9		46,3	42	40,6	39,4	37,9	36,3	33,8	31,3	19,6	584	21,5	584	19,0
CRXM 9/5	11,3	45	CRX 9/5	4,9	5	2,2	3	2,3		58,1	52,5	50,8	49,2	47,2	45	42,5	38,8	24,4	614	23,5	614	22,0
CRXM 9/6	12,8	45	CRX 9/6	5,2	6	2,2	3	2,7		70	63	61,2	58,8	56,7	54,4	51,2	46,7	29,2	644	24,0	644	22,5
-	-	-	CRX 9/7	6,2	7	3	4	3		81,3	73,7	71,3	68,8	66,3	63,7	59,5	54,5	34,2	-	-	674	24,5
-	-	-	CRX 9/8	6,7	8	3	4	3,4		93	83,8	81,3	78,8	75,6	72,5	67,9	62,5	39,2	-	-	704	25,0
-	-	-	CRX 9/9	7,3	9	3	4	3,8		105	94,6	91,3	88,7	85	81,3	76,3	70	43,8	-	-	734	25,5

DESCRIPTION

- 1 Delivery casing
 - 2 Screw
 - 3 External jacket
 - 4 O-Ring
 - 5 Screw
 - 6 Washer
 - 7 Wear ring (1)
 - 8 Suction washer
 - 9 First stage casing
 - 10 Stage casing
 - 11 Last stage casing
 - 12 Impeller
 - 13 Impeller nut
 - 14 Washer
 - 15 Oil chamber cover
 - 16 Mechanical seal
 - 17 Retaining ring, split
 - 18 Shoulder ring
 - 19 Spacer
 - 20 Spacer sleeve
 - 21 Motor cover, pump side
 - 22 O-ring
 - 23 O-ring
 - 24 Cable gland
 - 25 Upper mechanical seal
 - 26 Circlip
 - 27 Pump side bearing
 - 28 Motor jacket with winding
 - 29 Float switch
 - 30 Jacket cover
 - 31 Shaft with rotor packet
 - 32 O-ring
 - 33 Bearing
 - 34 Motor end-shield, non-drive end
 - 35 Screw
 - 36 O-ring
 - 37 Compensating spring
 - 38 Cable.
- Inserted in stage casing,
cannot be supplied separately

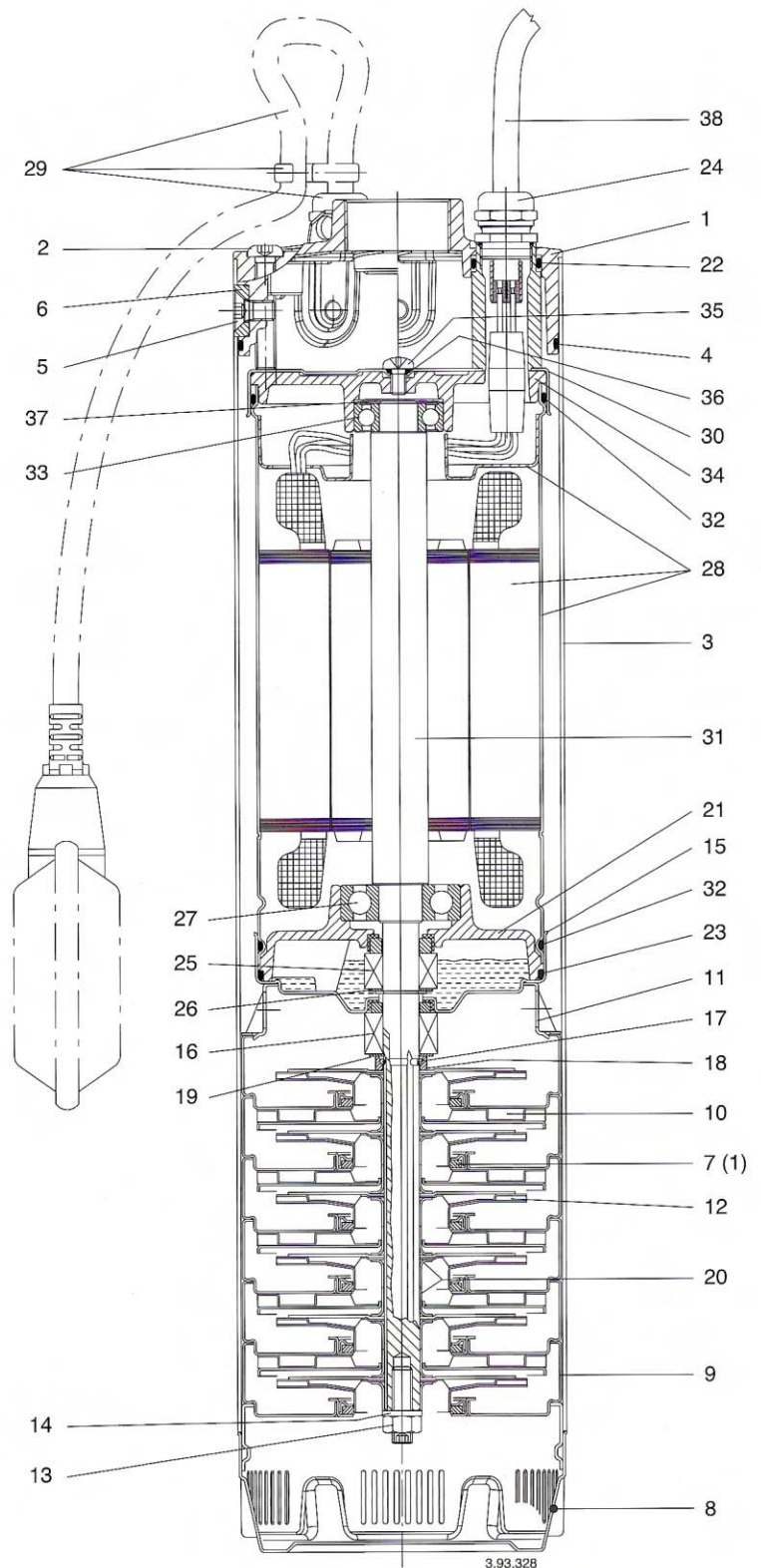

Supplied by:

Ernest
Electro
Engineering (Pty) Ltd.
ARMATURE & MOTOR REWINDING

370 Kruger Road, Strijdom Park, Randburg, South Africa
Tel: (011) 792 9550 / 1 / 2 Fax: (011) 792 9553
E-mail: eeeaman@mweb.co.za Website: ernestee.co.za

R8-30

8" RADIAL SUBMERSIBLE PUMPS

ERNEST ELECTRO PUMPS

50 Hz - $n \approx 2900$ rpm

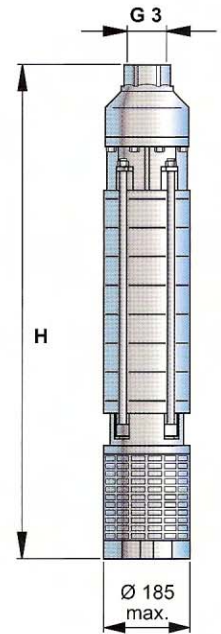
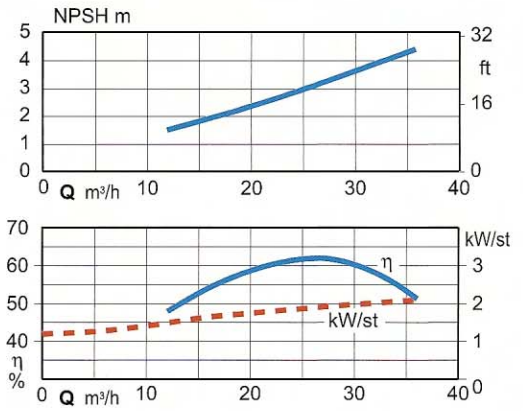
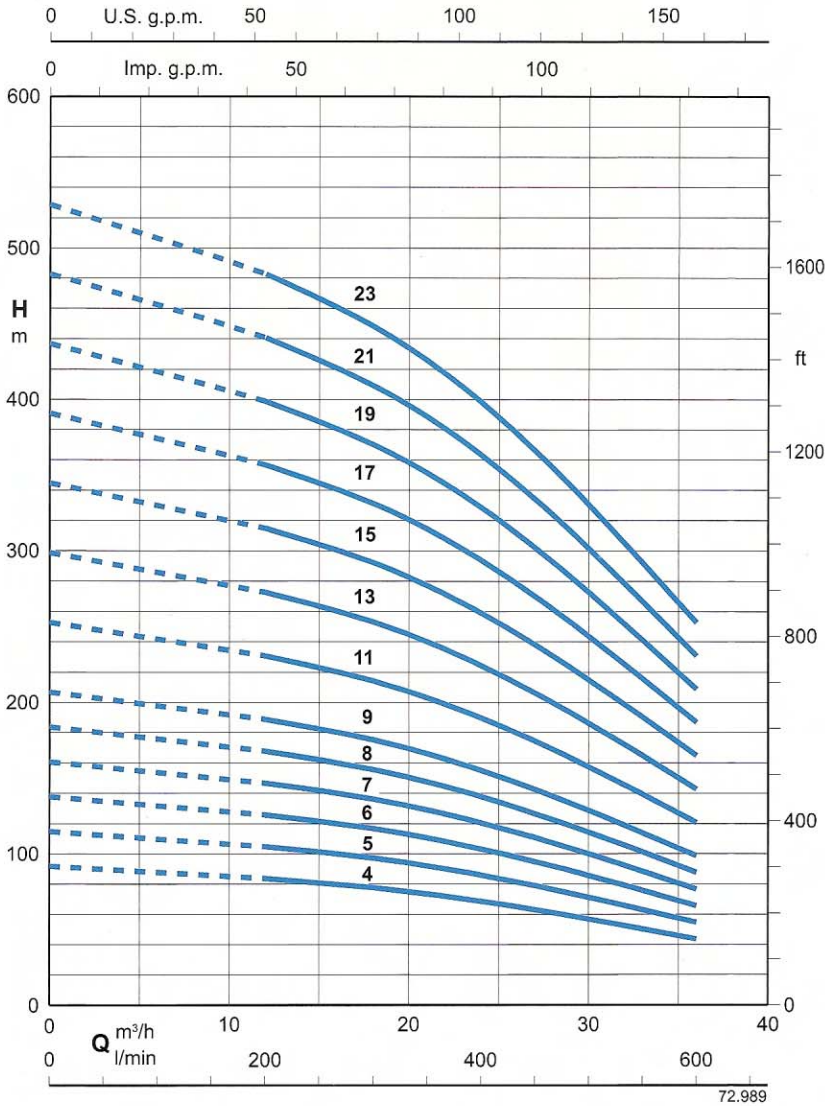

Supplied by:

Ernest Electro Engineering (Pty) Ltd.
ARMATURE & MOTOR REWINDING

370 Kruger Road, Strijdom Park, Randburg, South Africa
 Tel: (011) 792 9550 / 1 / 2 Fax: (011) 792 9553
 E-mail: eeeamanager@mweb.co.za Website: ernestee.co.za

TYPE	MOTOR		Q m³/h l/min	DELIVERY											H mm	kg
	kW	HP		0	12	15	18	21	24	27	30	36				
R8 30/4	9,2	12,5		92	84	82	78	74	68	63	56	44	810	58		
R8 30/5	11	15		115	105	102	98	92	85	78	70	55	875	64		
R8 30/6	13	17,5		138	126	122	117	110	102	94	84	66	940	70		
R8 30/7	15	20		161	147	142	136	128	119	109	98	77	1005	77		
R8 30/8	18,5	25		184	168	163	156	147	136	125	112	88	1070	83		
R8 30/9	22	30		207	189	183	175	165	153	140	126	99	1135	89		
R8 30/11	26	35		255	231	224	214	202	187	172	154	121	1265	101		
R8 30/13	30	40		299	273	265	253	239	221	203	182	143	1395	113		
R8 30/15	37	50		345	315	305	292	275	255	234	210	165	1525	125		
R8 30/17	37	50		391	357	346	331	312	289	265	238	187	1685	140		
R8 30/19	45	60		437	399	387	370	349	323	297	266	209	1900	158		
R8 30/21	45	60		483	441	428	409	386	357	328	294	231	2030	170		
R8 30/23	51	70		529	483	468	448	422	391	359	322	253	2160	183		

R8-60

Multi-Stage Submersible PUMPS
Clean Water Pumps

ERNEST ELECTRO PUMPS

50 Hz - $n \approx 2900$ rpm

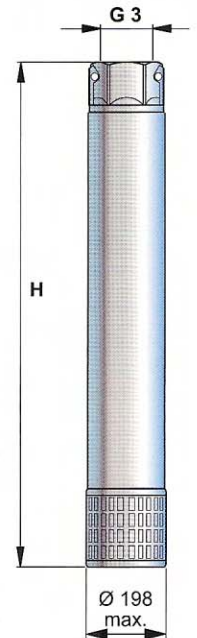
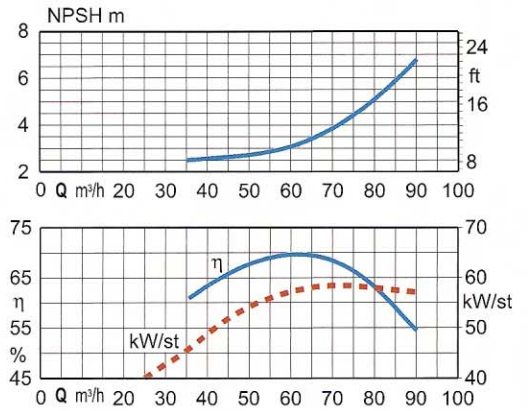
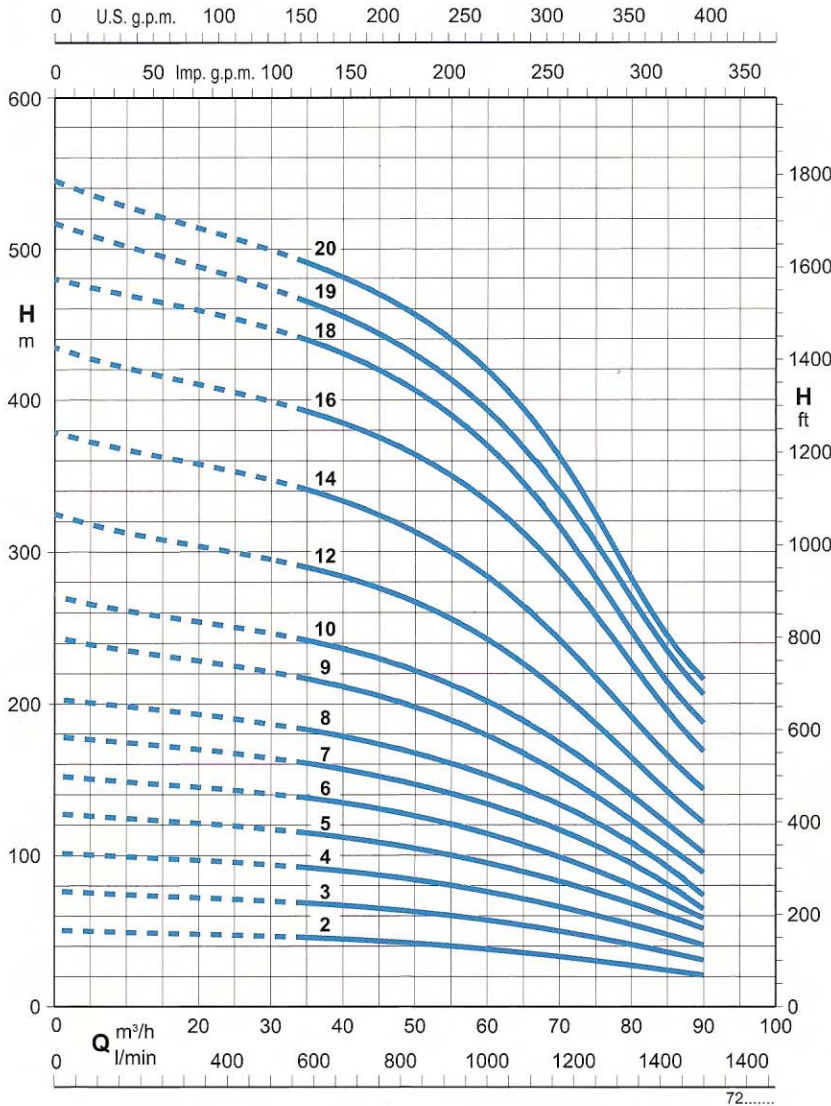

Supplied by:

Ernest Electro Engineering (Pty) Ltd.
ARMATURE & MOTOR REWINDING

370 Kruger Road, Strijdom Park, Randburg, South Africa
Tel: (011) 792 9550 / 1 / 2 Fax: (011) 792 9553
E-mail: eeeaman@mweb.co.za Website: ernestee.co.za

TIPO TYPE TYPE	MOTORE MOTOR MOTEUR		Q m³/h l/min	PORTATA - DELIVERY - DEBIT - CAUDAL											H mm	kg
	KW	HP		0	35	40	45	50	55	60	65	70	80	90		
R 8-60/2	9	12,5	H m HEAD	51	46	45	44	42	41	38	35	33	28	21	662	41
R 8-60/3	15	20		77	69	68	66	63	61	58	53	50	42	31	735	46
R 8-60/4	18,5	25		102	93	90	88	84	81	76	70	66	56	41	808	51
R 8-60/5	26	35		128	116	113	110	105	100	96	88	83	70	52	881	56
R 8-60/6	30	40		153	139	135	132	126	122	116	105	99	82	59	954	61
R 8-60/7	37	50		179	163	158	154	147	142	134	123	116	98	65	1027	66
R 8-60/8	37	50		204	185	180	176	168	162	153	141	132	112	74	1200	71
R 8-60/9	45	60		245	217	213	204	199	191	180	169	153	124	89	1301	76
R 8-60/10	51	70		272	242	237	233	224	216	202	191	174	140	102	1374	81
R 8-60/12	59	80		326	289	284	279	269	258	242	229	211	163	122	1520	91
R 8-60/14	66	90		380	342	338	326	314	302	285	262	241	194	144	1666	101
R 8-60/16	75	100		436	392	386	380	369	354	333	311	282	232	169	1912	111
R 8-60/18	92	125		481	441	434	427	415	391	370	340	312	254	188	2058	121
R 8-60/19	92	125		518	465	458	451	435	416	393	363	338	274	207	2131	126
R 8-60/20	92	125		546	490	482	474	461	444	421	396	355	288	217	2204	131

R8-75

8" RADIAL SUBMERSIBLE PUMPS

ERNEST ELECTRO PUMPS

50 Hz - $n \approx 2900$ rpm

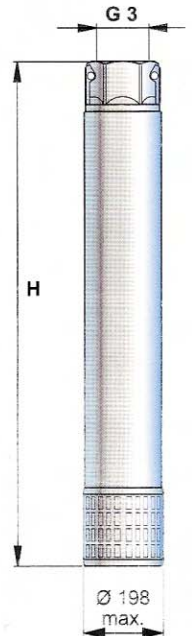
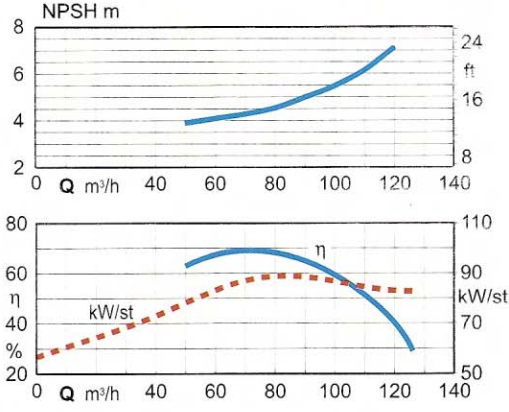
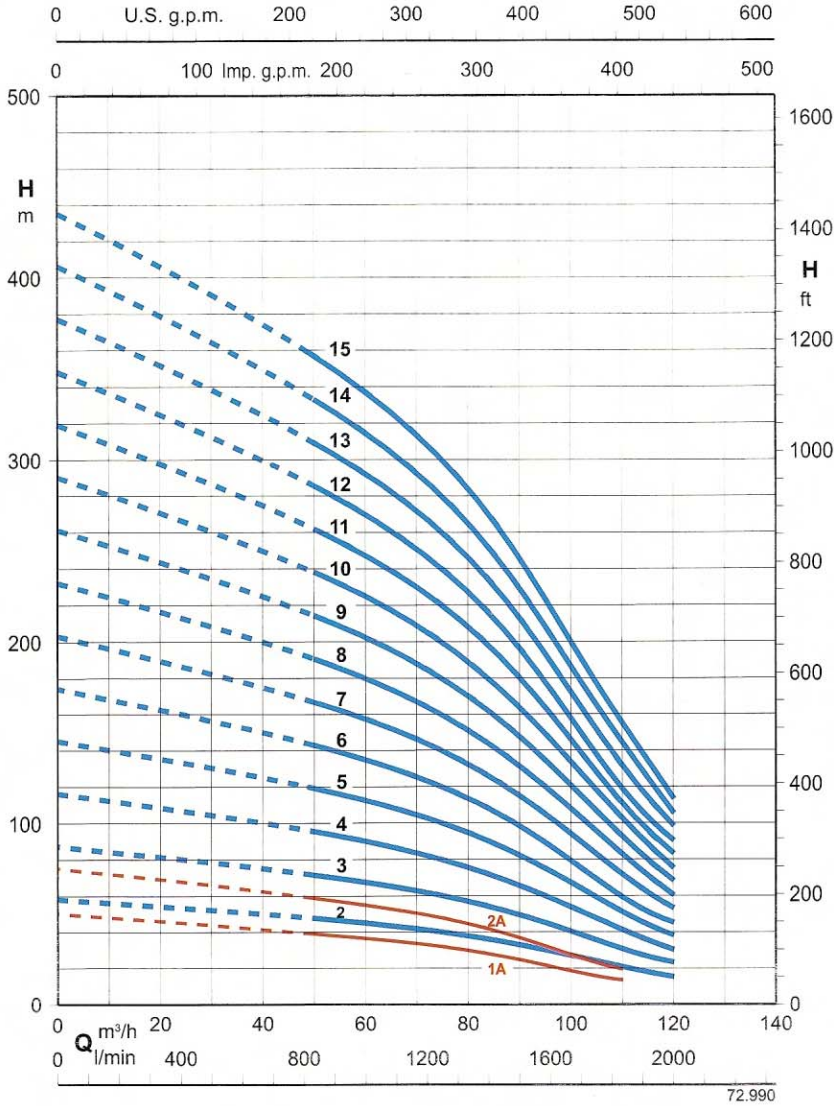

Supplied by:

Ernest Electro Engineering (Pty) Ltd.
ARMATURE & MOTOR REWINDING

370 Kruger Road, Strijdom Park, Randburg, South Africa
 Tel: (011) 792 9550 / 1 / 2 Fax: (011) 792 9553
 E-mail: eeeaman@mweb.co.za Website: ernestee.co.za

TYPE	MOTOR		Q m³/h l/min	DELIVERY												H mm	kg
	kW	HP		0	50	55	60	70	75	80	90	100	110	120			
R8-75/2A	11	15	H m HEAD	50	39	37	36	33	32	30	24	18	13		662	41	
R8-75/2	13	17,5		58	48	46	44	42	40	38	33	26	21	15	662	41	
R8-75/3A	15	20		75	59	56	54	50	48	45	36	27	19		735	46	
R8-75/3	18,5	25		87	72	69	66	63	60	57	50	39	31	23	735	46	
R8-75/4	22	30		116	96	92	88	84	80	76	66	52	42	30	808	51	
R8-75/5	30	40		145	120	115	110	105	100	95	83	65	52	38	881	56	
R8-75/6	37	50		174	144	138	132	126	120	114	99	77	60	45	954	61	
R8-75/7	45	60		203	168	161	154	147	140	133	116	91	73	53	1054	66	
R8-75/8	45	60		232	192	184	176	168	160	152	132	105	84	60	1227	71	
R8-75/9	51	77		261	216	207	198	189	180	171	149	117	94	68	1300	76	
R8-75/10	59	80		290	240	230	220	210	200	190	165	130	104	75	1373	81	
R8-75/11	66	90		319	264	253	242	231	220	209	182	142	112	83	1446	86	
R8-75/12	75	100		348	288	276	264	252	240	228	198	154	120	90	1519	91	
R8-75/13	75	100		377	312	299	286	273	260	247	215	168	133	98	1592	96	
R8-75/14	92	125		406	336	322	308	294	280	266	231	182	146	105	1665	101	
R8-75/15	92	125	435	360	345	330	315	300	285	248	195	157	113	1738	106		

S8-70

8" MIXED-FLOW
SUBMERSIBLE PUMPS

ERNEST ELECTRO PUMPS

50 Hz - n ≈ 2900 rpm

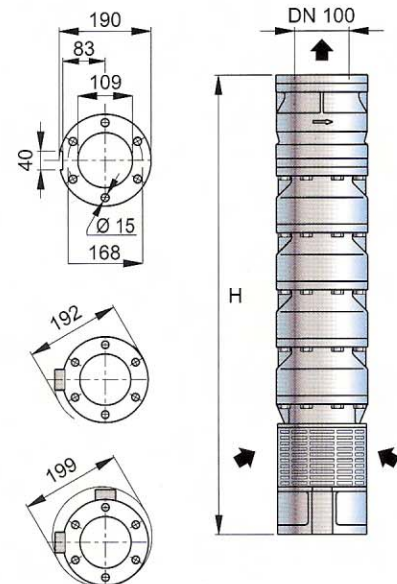
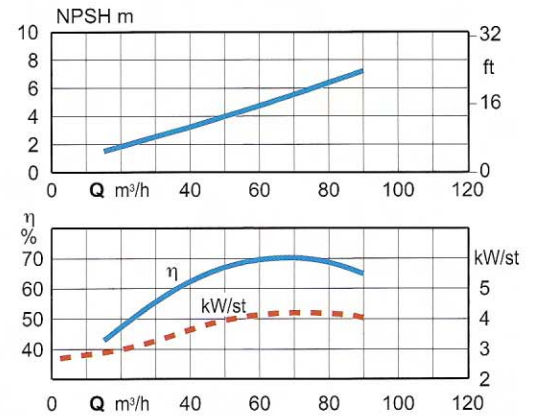
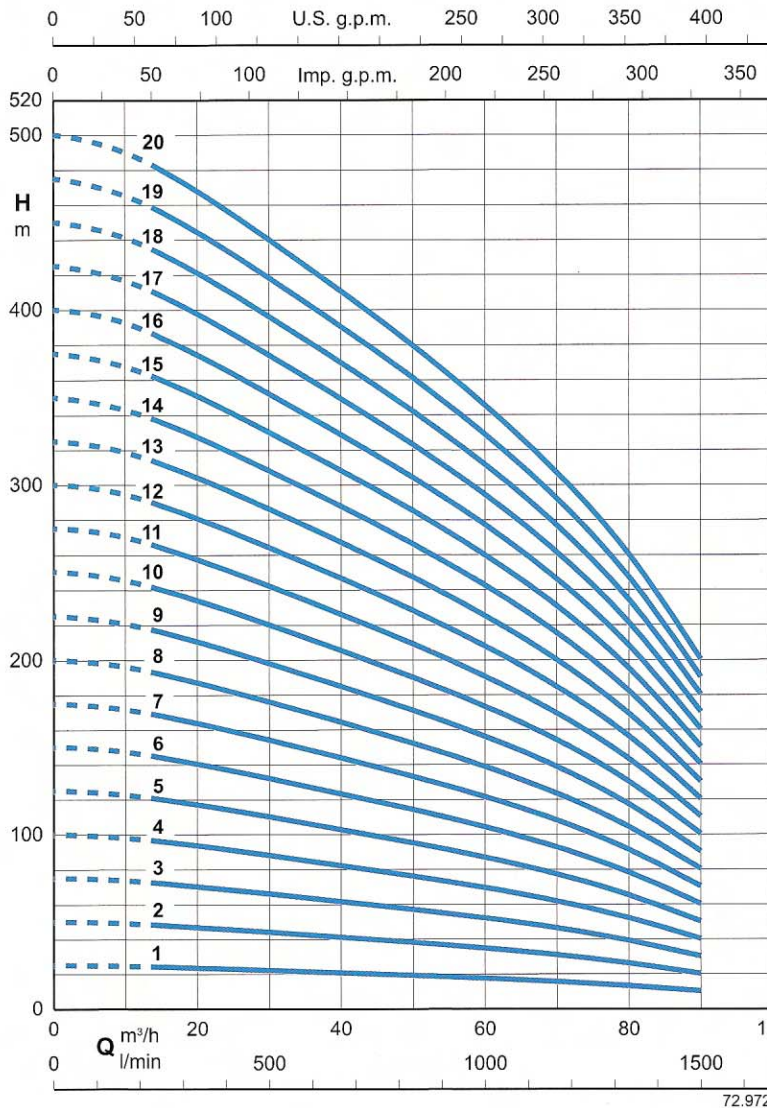

Supplied by:

Ernest Electro Engineering (Pty) Ltd.
ARMATURE & MOTOR REWINDING

370 Kruger Road, Strijdom Park, Randburg, South Africa

Tel: (011) 792 9550 / 1 / 2 Fax: (011) 792 9553

E-mail: eeeaman@mweb.co.za Website: ernestee.co.za

TYPE	MOTOR		Q m³/h l/min	DELIVERY													MOTORE MOTOR	H mm	kg
	kW	HP		0	15	20	30	40	50	60	65	70	75	80	90				
S8-70/1	4	5,5	0	250	333	500	666	833	1000	1083	1166	1250	1333	1500	6"	607	40		
S8-70/2	9,2	12,5	25	24	23	22	21	19	18	16	15	14	13	10		742	52		
S8-70/3	13	17,5	50	48	46	44	41	38	35	32	30	28	26	20		877	62		
S8-70/4	18,5	25	75	72	69	66	62	57	53	48	45	42	39	30		1012	73		
S8-70/5	22	30	100	96	92	88	82	76	70	64	60	56	52	40		1191	88		
S8-70/6	26	35	125	120	115	110	102	95	88	82	75	72	65	50		1326	98		
S8-70/7	30	40	150	144	138	132	123	114	105	98	90	85	78	60		1461	109		
S8-70/8	37	50	175	168	161	154	143	133	122	115	105	100	91	70		1596	120		
S8-70/9	45	60	200	192	184	176	164	152	140	131	120	115	104	80		1731	131		
S8-70/10	45	60	225	216	207	198	184	171	157	148	135	130	117	90		1866	143		
S8-70/11	51	70	250	240	230	220	205	190	175	164	150	144	130	100	2001	153			
S8-70/12	55	75	275	264	253	242	225	209	192	180	165	160	143	110	2136	165			
S8-70/13	59	80	300	288	276	264	246	228	210	197	180	173	156	120	2271	175			
S8-70/14	59	80	325	312	299	286	266	247	227	213	195	188	169	130	2406	185			
S8-70/15	66	90	350	336	322	308	287	266	245	230	210	202	182	140	2541	195			
S8-70/16	75	100	375	360	345	330	307	285	262	246	225	216	195	150	2676	222			
S8-70/17	75	100	400	384	368	352	328	304	280	263	240	231	208	160	2811	235			
S8-70/18	92	125	425	408	391	374	348	323	297	279	255	245	221	170	2946	249			
S8-70/19	92	125	450	432	414	396	369	342	315	296	270	260	234	180	3081	263			
S8-70/20	92	125	475	456	437	418	389	361	332	312	285	274	247	190	3216	277			
			500	480	460	440	410	380	350	330	300	289	260	200					

S8-100

8" MIXED-FLOW
SUBMERSIBLE PUMPS

ERNEST ELECTRO PUMPS

50 Hz - $n \approx 2900$ rpm

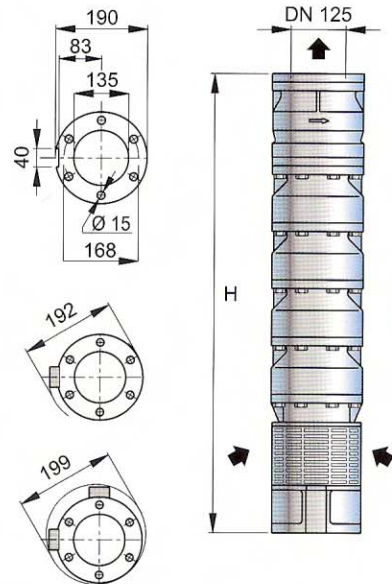
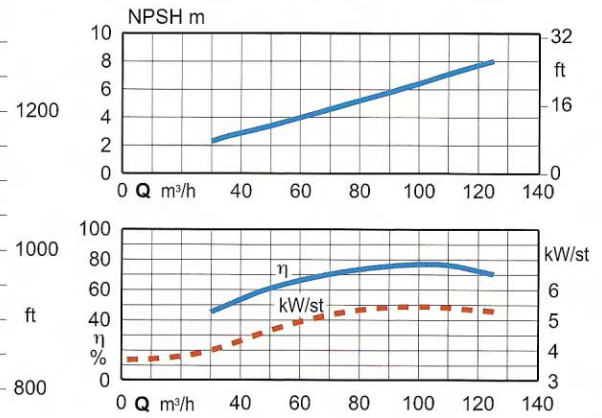
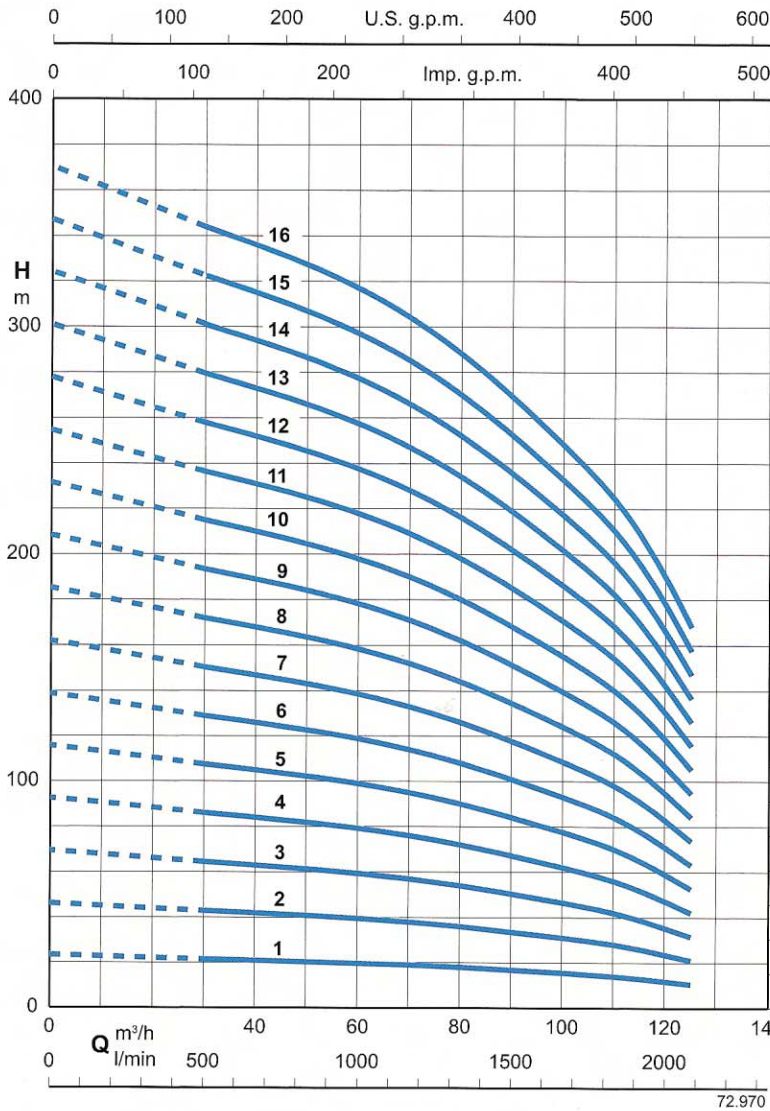

Supplied by:

Ernest Electro Engineering (Pty) Ltd.
ARMATURE & MOTOR REWINDING

370 Kruger Road, Strijdom Park, Randburg, South Africa
Tel: (011) 792 9550 / 1 / 2 Fax: (011) 792 9553
E-mail: eeeaman@mweb.co.za Website: ernestee.co.za

TYPE	MOTOR		Q m³/h l/min	DELIVERY											
	kW	HP		0	30	40	50	60	70	80	90	100	105	110	125
S8-100/1	5,5	7,5	H m HEAD	23	22	21	21	20	19	18	17	16	15	14	11
S8-100/2	11	15		46	43	42	41	40	38	36	34	31	30	28	21
S8-100/3	18,5	25		69	65	63	62	60	57	54	51	47	45	42	32
S8-100/4	22	30		92	86	84	82	80	76	72	68	62	60	56	42
S8-100/5	30	40		115	107	105	102	100	95	90	85	78	75	70	53
S8-100/6	37	50		138	129	126	123	120	114	108	102	93	90	84	63
S8-100/7	45	60		161	150	147	143	140	133	126	119	108	105	98	74
S8-100/8	45	60		184	172	168	164	160	152	144	136	124	120	112	84
S8-100/9	51	70		207	193	189	184	180	171	162	153	139	135	126	95
S8-100/10	55	75		230	215	210	205	200	190	180	170	155	150	140	105
S8-100/11	66	90		253	236	231	225	220	209	198	187	170	165	154	115
S8-100/12	66	90		276	258	252	246	240	228	216	204	186	180	168	126
S8-100/13	75	100		300	279	273	266	260	247	234	221	201	195	182	136
S8-100/14	92	125		322	301	294	287	280	266	252	238	217	210	196	147
S8-100/15	92	125		345	322	315	307	300	285	270	255	232	225	210	157
S8-100/16	92	125		368	344	336	328	320	304	288	272	248	240	224	168

MOTOR	H mm	kg
6"	607	40
	742	52
	877	62
	1012	73
	1191	88
8"	1326	98
	1461	109
	1596	120
	1731	131
	1866	143
	2001	153
	2136	165
	2271	175
	2406	185
	2541	195
	2676	205

S8-150

8" MIXED-FLOW
SUBMERSIBLE PUMPS

ERNEST ELECTRO PUMPS

50 Hz - n ≈ 2900 rpm

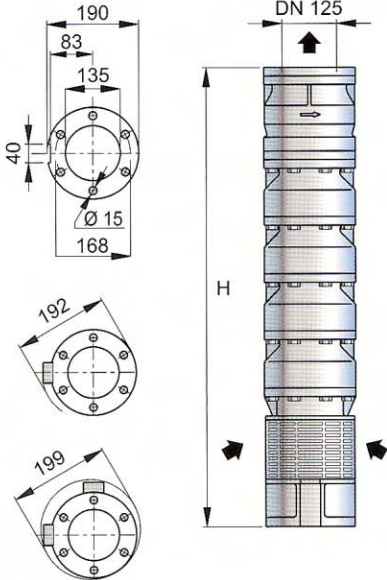
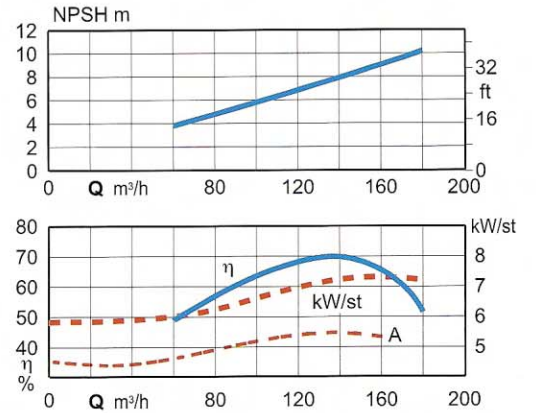
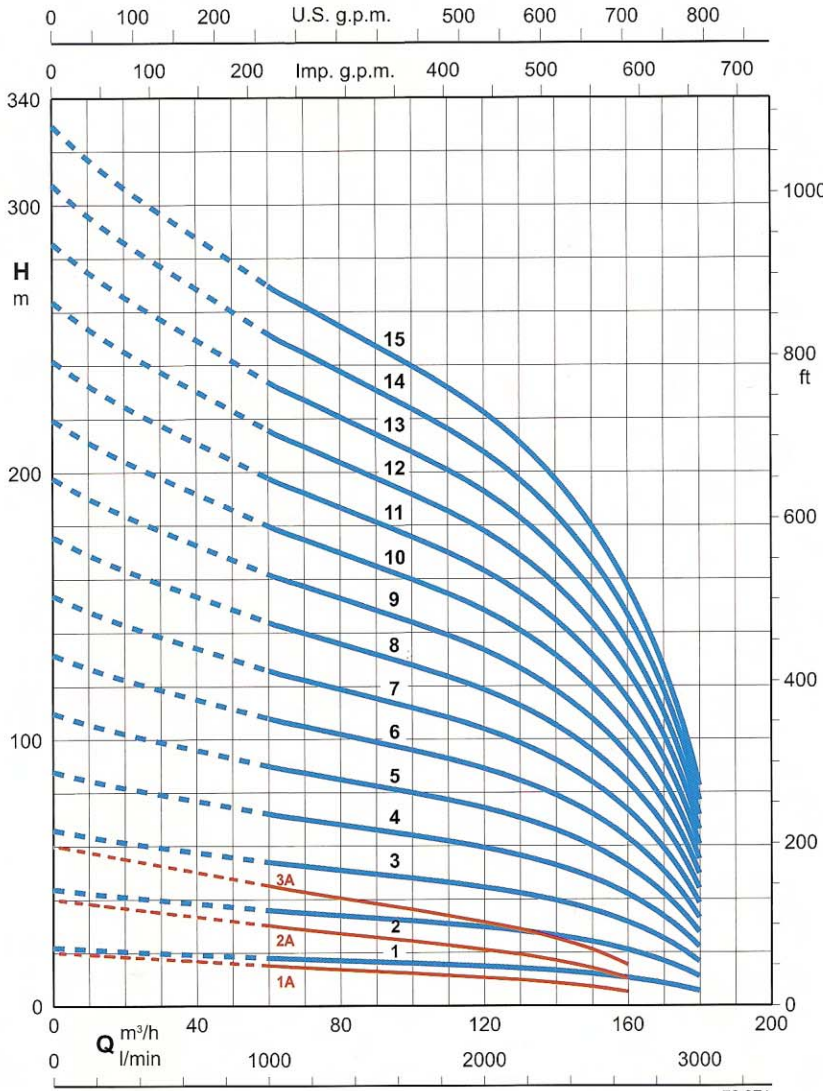

Supplied by:

Ernest Electro Engineering (Pty) Ltd.
ARMATURE & MOTOR REWINDING

370 Kruger Road, Strijdom Park, Randburg, South Africa

Tel: (011) 792 9550 / 1 / 2 Fax: (011) 792 9553

E-mail: eeeaman@mweb.co.za Website: ernestee.co.za

TYPE	MOTOR		Q m³/h l/min	DELIVERY													MOTOR	H mm	kg
	kW	HP		0	60	70	80	90	100	110	125	140	150	160	180				
S8-150/1A	5,5	7,5	20	15	14	13,5	13	12	11	10	8	7	5		607	40			
S8-150/1	7,5	10	22	18	18	17	17	16	16	15	13	12	11	6	607	40			
S8-150/2A	11	15	40	30	28	27	26	24	22	20	16	14	10		742	52			
S8-150/2	15	20	44	36	35	34	33	32	31	29	26	23	21	11	742	52			
S8-150/3A	18,5	25	60	45	42	41	39	36	34	30	25	21	15		877	62			
S8-150/3	22	30	66	54	53	51	50	48	47	44	39	35	32	17	877	62			
S8-150/4	30	40	88	72	70	68	66	64	62	58	52	46	42	22	1012	73			
S8-150/5	37	50	110	90	88	85	83	80	78	73	65	58	53	28	1191	88			
S8-150/6	45	60	132	108	105	102	99	96	93	87	78	69	63	33	1326	98			
S8-150/7	51	70	154	126	122	119	115	112	108	101	91	81	74	39	1461	109			
S8-150/8	59	80	176	144	140	136	132	128	124	116	104	92	84	44	1596	120			
S8-150/9	66	90	198	162	157	153	148	144	139	130	117	103	95	50	1731	131			
S8-150/10	75	100	220	180	175	170	165	160	155	145	130	115	105	55	1866	143			
S8-150/11	92	125	242	198	192	187	181	176	170	159	143	126	115	61	2001	153			
S8-150/12	92	125	264	216	210	204	198	192	186	174	156	138	126	66	2136	165			
S8-150/13	110	150	286	234	227	221	214	208	201	188	169	149	136	72	2271	175			
S8-150/14	110	150	308	252	245	238	231	224	217	203	182	161	147	77	2406	185			
S8-150/15	110	150	330	270	262	255	247	240	232	217	195	172	157	83	2541	195			